

Design guide

Superheat controller

Type EKE 1A, EKE 1B, EKE 1C (SW 1.15)



The flexible pre-programmed EKE 1 superheat controller from Danfoss provides ultimate software control, allowing you to tailor the performance of your system to your exact requirements. EKE is ideal for controlling a wide range of commercial air conditioning and refrigeration applications, such control helps you to achieve the highest efficiency in the system reducing the operational cost by upto 20% with minimal effort.

EKE is generally used where there is a requirement for accurate control of superheat or temperature control in connection with air conditioning and refrigeration. The superheat is regulated to the lowest possible value within a short period of time. It regulates the superheat of the evaporator by charging optimally even when there are great variations of load resulting in reduction of energy consumption and operational cost.

Typical Applications:

- Chillers
- Processing plant / Cabinet cooling
- Cold store (air coolers)
- A/C plant / Air conditioning
- Heat pumps. Residential Heat Pump
- Transport cooling

Features / benefits

Power Supply:

- Easy wiring layout.
 - Isolation: No risk of causing short circuits when connection to other units through power supply.
 - Increased system robustness.
- 24 V AC or 24 V DC: flexibility in selecting different transformer.

Valve Driver:

- Drives bipolar and unipolar valves with selectable driving method.
- Up to 1.0 A max. peak and 750 mA RMS current per winding: compatibility with more valves.
- Microstepping excitation: increase system performance compare to other driving techniques.
- It eliminates the noise, resonance and vibration problem and increase step accuracy and resolution.

Microprocessor:

- 3x (potentially 5x) faster than controllers available in market.

Service:

- Plug and Play installation. Easy and fast configuration via Wizard. Free communication software for setup and data logging.



For More
information on
EKE product

Analog inputs:

Various programmable inputs available

- Differential low voltage input available.
- Flexible choice of superheat sensor type: PT1000 or NTC.
- High precision and accuracy for any selected input type.
- Strong and efficient noise and disturbance filters.
- Signal pass-band can be defined by software: adaptation to speed of the process to be controlled.

Digital Inputs:

- Provides the fast input to initiate a selectable action.
- Up to 3x digital inputs.

User Interface: External display

- High-end design with flexible large graphical display.
- Keyboard with six key.

Connectivity:

CAN / CAN RJ / MODbus RS485 RTU (EKE 1B / EKE 1C)

Key Software:

- Energy saving Superheat Control logic: Minimum stable superheat, LoadAp, Fixed SH, Delta Temp.
- Safety protection: MOP, LOP, min. S4, HCTP, SH close.
- Improved and fast starts up with rapid temperature pull down time.
- Feature focus on specific application e.g Heat pump, chiller.
- Ensure longevity of the stepper valve.

Table of content

1.0	Ordering	3			
1.1	Hardware comparison	3			
1.2	Product label and Identification	3			
1.3	Dimensions: EKE 1A, EKE 1B, EKE 1C	4			
1.4	EKE range	4			
2.0	EKE superheat Controller Tools	5			
2.1	Accessories	6			
3.0	Main features overview	7			
3.1	Hardware	7			
3.2	Software	8			
3.3	Typical features used in various applications	9			
4.0	Specification	10			
4.1	General specification	10			
4.2	Electrical specification	10			
4.3	Inputs / outputs	11			
5.0	Connection	12			
5.1	EKE 1A connection overview	13			
5.2	EKE 1B connection overview	14			
5.3.1	EKE 1C - Front board connection overview	15			
5.3.2	EKE 1C - Back board connection overview	16			
6.0	Installation	17			
6.1	General installation	17			
6.2	Sensor mounting	17			
6.2.1	Temperature sensor	17			
6.2.2	Pressure transmitter mounting	17			
6.2.3	Sharing pressure sensor	17			
6.2.4	Pressure/ Temperature signal sharing in EKE 1C via CanBus	18			
6.2.5	Using external signal values via communication	18			
6.3	Sensor Correction	18			
6.4	Shared input signal	18			
6.5	Shared DI inputs	19			
6.6	Sharing power supply and battery back up	19			
6.7	Cabling	20			
6.7.1	Cable length	20			
7.0	Stepper motor valve	21			
7.1	For non Danfoss M12 cable	21			
7.2	Danfoss valve connection	21			
7.3	Stepper motor valve parameters	22			
7.4	Useful Valve parameters for various application	24			
8.0	Modbus communication	25			
8.1	Modbus RTU setting	25			
8.2	Addressing conversion	25			
8.3	RS485 bus function codes overview	26			
8.4	Example: MODBUS communication	26			
9.0	User interface: Display MMIGRS2	27			
9.1	Connection	27			
9.2	Main screen	28			
9.3	Display Units and Password	28			
10.0	Wizard set up	30			
11.0	User interface KoolProg	31			
11.1	Setting up	32			
11.2	Main Screen	32			
11.3	Service Menu	33			
11.4	Graph- Datalogger	33			
12.0	Configuration	34			
12.1	Quick guide for parameter selection	34			
12.2	Before starting controller checklist	35			
12.3	First Start up	36			
13.0	EKE Application	37			
13.1	Driver	37			
13.3	Controller	38			
14.0	Driver mode	39			
14.1	Using Analog signal	39			
			14.2	Using Communication bus	39
			14.3	Switching between Auto and manual mode	39
			15.0	Manual Mode	40
			15.1	Manual OD from preset parameter via DI	40
			15.2	Manual control of Relay	40
			15.3	Manual control Valve	40
			15.4	Manual Homing	40
			16.0	Temperature control	41
			16.1	ON/OFF thermostat	41
			16.2	Modulating thermostat (MTR)	42
			17.0	Superheat reference calculation methods	44
			17.1	Comparison between SH reference	44
			17.2	MSS	45
			17.3	Fixed reference	46
			17.4	Load AP	46
			17.5	Delta temperature reference	47
			18.0	SH or Temp. Reference via External signal	48
			18.1	SH reference	48
			18.2	Temperature reference	48
			18.3	Compressor feed forward SH reference	49
			19.0	General Limiter	50
			19.1	Priority of limiters	50
			19.2	Superheat close	51
			19.3	Lowest Operating Pressure (LOP)	51
			19.4	High condensing temperature protection	52
			19.5	Min. S4 / leaving media	53
			19.6	Maximum Operating Pressure (MOP)	54
			20.0	Start up	55
			20.1	P - Control	55
			20.2	Start OD with protection	55
			20.3	Fixed OD and time	55
			21.0	Defrost Sequence	56
			22.0	Reversible systems, dual setting of control parameters	57
			23.0	Fail safe operation	58
			24.0	Service Mode	59
			25.0	Alarms	60
			25.1	Actions following an alarm	60
			25.2	Lack of valve capacity Alarm	60
			25.3	Superheat Alarm	61
			26.0	Alarm and error table	62 - 65
			27.0	Trouble shooting	66 - 70
			Appendix 1	Acronyms and abbreviations.	71
			Appendix 2	General comparison between AKS and NSK Pressure transmitter	71
			Appendix 3	MMIGRS2 Display setting	72
			Appendix 4	Defining new refrigerant	72
			Appendix 5	Flammable application	73
			Appendix 6	Factory Reset	73
			Appendix 7	Overdrive enable	74
			Appendix 8	Typical applications with	75
			A.	Chiller (cooling only)	75
			B.	Reversible chillers (Air to water)	75
			C.	Reversible heat pump	76
			D.	A/C air handler	77
			E.	Cold room	77
			F.	Multi evaporator	77
			Appendix 9	Parameters List Explanations	78 - 83
				User interface module MMIGRS2	84 - 85
				Gateway MMIMYK	86 - 87
				Transformers ACCTRD	88
				Transformers AK-PS	89
				Probe ACCPBT	90
				Cable ACCCBI	91

Design Guide | Superheat controller type EKE 1A, EKE 1, EKE 1C

1.0 Ordering EKE controller

Type	Pack format	Code no.
Electronic controller EKE 1A	Single pack	080G5300
Electronic controller EKE 1B	Single pack	080G5350
Electronic controller EKE 1C	Single pack	080G5400
Accessories		
MMIGRS Remote Display	Single pack	080G0294
MMIMYK gateway	Single pack	080G0073

1.1 Hardware comparison

		EKE 1A	EKE 1B	EKE 1C
Power Supply				
Power supply type	24 V AC / DC \pm 20%	•	•	•
Share power supply		•	•	•
Battery backup input	18 - 24 V DC	•	•	•
Data Communication				
MODbus	RS 485 RTU	-	•	•
Wired CANbus	To link Danfoss products	-	-	•
CANbus RJ	Danfoss MMI service port	•	•	•
Inputs				
Temperature Sensor Type	PT1000	-	-	•
	NTC 10K, type EKS	•	•	•
	NTC 10K, type ACCPBT	•	•	•
	NTC 10K, type Sensata	•	•	•
No of temperature sensors		1	2	3
Pressure Transmitter types	Ratiometric 0.5 - 4.5 V DC	•	•	•
	0 – 20 mA signal	-	-	•
	1 – 5 V / 0 – 10 V	•	•	•
No of pressure sensors		1	1	2 or (1 P and 1 ext. ref.)
Share Pressure Signal	Up to 5 devices	•	•	-
	Via wired CANbus	-	-	•
Read external sensor value	Via MODbus	-	•	•
External reference	4 – 20 mA	-	-	•
	0 – 20 mA	-	-	•
	User defined current	-	-	•
	0 – 10 V	•	•	•
	1 – 5 V	•	•	•
	User defined voltage	•	•	•
No. of external reference		1	1	1
Digital Input Dry contact	(4 possible functions)	3	2	2
Outputs				
Digital output		1	1	1
Class of insulation	Class II	•	•	•
Relay	SPDT 3A max.	1	1	1
Relay functions	Alarm or NC function	•	•	•

1.2 Product label and Identification

Product name — Superheat Controller
 Product type - code no. — EKE 1C - 080G5400 PV01
 Electrical specification — 24V AC/DC 50/60Hz
 Approvals — CE ENEC C RU US
 Product Version — PV01
 Product QR code — [QR Code]
 Country of Origin — MADE IN SLOVAKIA
 Manufacturer Address — Danfoss A/S, 6450 Nordborg, Denmark

Example: EKE 1C

1.3 Dimensions:
EKE 1A, EKE 1B, EKE 1C

All dimensions in mm.
Weight:
EKE 1C : 190 g
EKE 1A / EKE 1B : 152 g

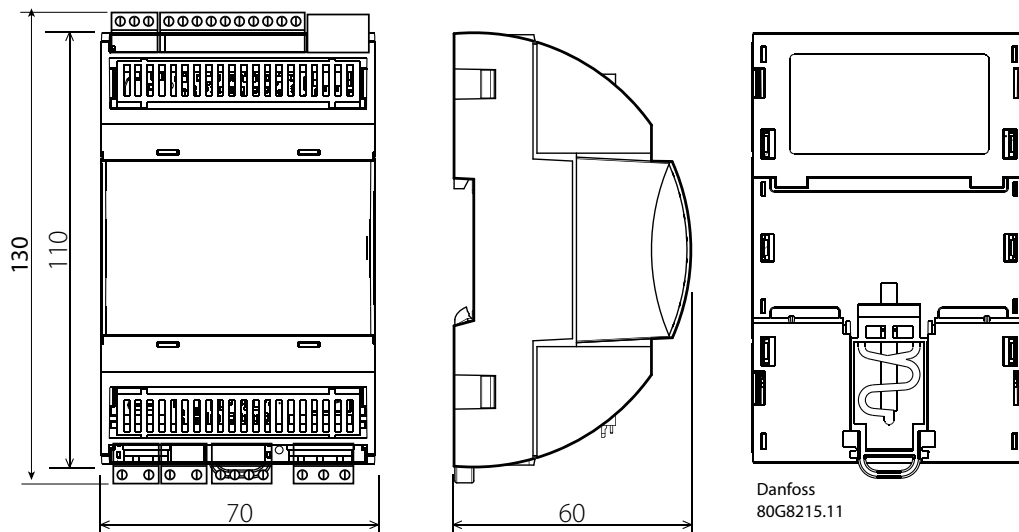

1.4 EKE range



2.0 EKE superheat Controller Tools

KoolProg PC tool

The KoolProg PC tool is the main tool to interact with the EKE injection controller. It connects via USB connection to the EKE service port via MMIMYK gateway. The MMIMYK can be used as USB to CAN converter to establish the point to point connection.

Features

- Easy connection
- Edit parameter in live mode
- Edit parameters on offline configuration
- Load of multiple predefined configurations
- Secure writing of parameters
- Setup wizard
- Multiple language support

MMIGRS2

Can be used:

- For EKE 1A / EKE 1B / EKE 1C controllers as external display to change controller settings. It is connected via the CAN RJ12 telephone connector to the controller (point to point connection)
- As fixed build in display e.g. in cabinet door. In this case (permanent installation) the wired CAN port should be used if available.

System Master

The System Master controls the EKE superheat controller over the network or via analog or digital signals. On the MODbus it acts as a master and the EKE acts as a slave. The master could be e.g. a Danfoss MCX controller or a PLC system.

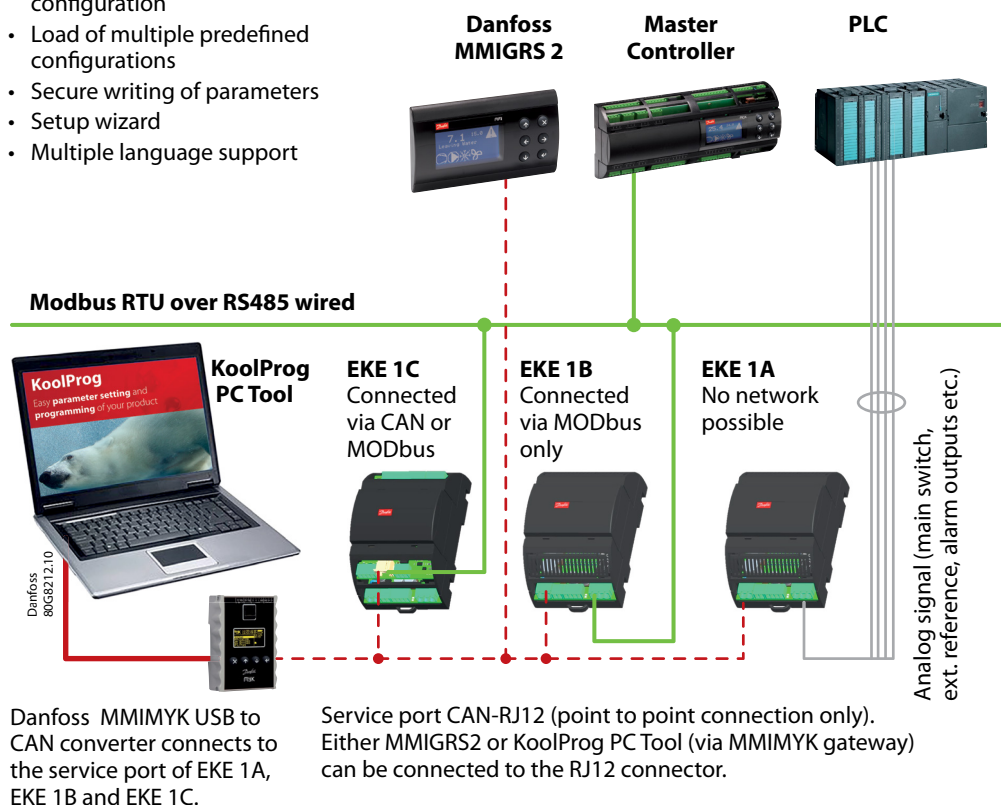

2.1 Accessories and Related products

MMIGRS2 Display	Power Supply	MMIMYK Gateway
		
User interface module MMIGRS2 Display.	AK-PS Input: 100 - 240 V AC / 45 - 65 Hz Output: 24 V DC: available with 18 VA, 36 VA and 60 VA ACTRD Input: 230 V AC, 50 - 60 Hz Output: 24 V AC, available with 12 VA, 22 VA and 35 VA	MMIMYK device is used as a gateway to connect EKEs and the KoolProg PC software for parameter setting or data logging.
Pressure Transmitter	Temperature Sensor	
		
AKS Pressure Transmitter Available with ratiometric and 4 - 20 mA. NSK Ratiometric Pressure Probe. Pressure probe 4 - 20 mA.	PT 1000 AKS is a High precision temp. sensor AKS 11 (preferred), AKS 12, AKS 21 ACCPBT PT1000 NTC sensors EKS 221 (NTC-10 Kohm) ACCPBT NTC Temp probe (IP 67 / 68)	
ACCCBI Cable	Stepper motor valves	M12 Angle Cables
		
ACCCBI cables for MMI display and gateway.	EKE is compatible with Danfoss stepper motor valves i.e Danfoss ETS 6, ETS, KVS, ETS Colibri®, KVS colibri®, CTR, CCMT.	Various lengths of standard M12 cable are available for connecting stepper motor valves.

3.0 Main Feature overview

3.1 Hardware

Digital inputs	<p>The number of available DI inputs differs in various model of EKE controller. This feature is especially useful for systems where the EKE is not connected to a system controller via data communication. In this case the digital inputs can be used to interact with the EKE.</p> <p>The available digital inputs DI can be used for the following functions: a. Injection control ON/OFF. b. Defrost sequence. c. Heating and cooling selection mode. d. Preset OD.</p> <p>Injection control ON/OFF</p> <p>The controller can be started and stopped externally via a contact function connected to DI input terminals and activating the feature. Regulation is stopped when the connection is open. The function must be used when the compressor is stopped. The controller then closes the valve so that the evaporator is not charged with refrigerant. This can also be achieved using Modbus by setting the R012 Main Switch parameter.</p> <p>Heating and cooling selection mode</p> <p>This feature is useful especially for Heat pump application where two sets of superheat settings is required. Heat / Cool selection is possible using digital input DI function or via RS485.</p>
Digital Outputs (Relay)	<p>The relay for the liquid line solenoid valve will operate when refrigeration is required. The relay for the alarm function works in such a way that the contact is closed in alarm situations and when the controller is de-energised.</p>
Handling power failure	<p>For safety reasons the liquid flow to the evaporator must be cut off if there is power failure for the controller. As the Stepper valve is provided with step motor, it will remain open in power failure situation. There are two ways of coping with this situation.</p> <p>One of the following two solutions can be applied in the system:</p> <ul style="list-style-type: none"> • Mounting of a solenoid valve in front of EEV • Mounting of a battery backup for EEV valve
Manual control	<p>The valve can be controlled manually by setting the desired opening degree via Analog signal or communication bus. A special service mode is also available for service and testing purpose.</p>
Analog Inputs	<p>The voltage signal e.g. 0 – 10 V can be used in all EKE controllers where as current signal e.g. 0 – 20 mA signal is only available in EKE 1C. The reference can be displaced in positive or negative direction.</p> <p>External Reference Signal :</p> <p>External Reference such as analog signal can be used either :</p> <ol style="list-style-type: none"> a. To manually drive the stepper motor valve to a desired opening degree b. To displace temperature reference or superheat reference.
Communication: RS485 RTU/ CANbus	<p>The controller can be provided with data communication so that it can be connected to other devices in the systems that can be connected with a data communication. In this way operation, monitoring and data collection can be performed from one device i.e PC – which will be benefit for the diagnostic or during the installation processes.</p> <p>Reading External sensor values:</p> <p>It is possible to substitute the physical sensors of the EKE controller by sending external sensor values via MODbus. These external values need to be updated frequently.</p>
Light-emitting diodes (LEDs)	<p>Two sets of light-emitting diodes makes it possible to follow the operation status of the valve and the controller . They indicate the following:</p> <ul style="list-style-type: none"> • Power/data transmission and Alarm/Error indication • Stepper valve operational status

3.2 Software

Minimum Stable Superheat (MSS)	The superheat control algorithm will attempt to regulate the superheat down to the lowest stable value between the minimum superheat setting, "Min SH" and the maximum superheat setting, "Max. SH".
LoadAp Superheat	LoadAP is an abbreviation of "load defined reference". LoadAP will adjust reference to be higher if load is higher. Load is indicated by the OD of valve. LoadAP is a kind of preprogrammed MSS curve. This method will give a robust SH reference and can in many case be the best fit for systems.
Fixed Superheat	This feature is used in a system where a stable fixed superheat is required.
Delta temp. superheat	With delta temp., SH reference is calculated as a ratio between the media temperature and evaporator temperature. This reference mode is only possible if media temperature (S3) sensor is available and if the system uses fin and tube evaporator.
Temperature Control	EKE has a feature to regulate the temperature control. This can be done with either thermostat cut in -cut out function or using Modulating Thermostat (MTR) i.e Area control of Evaporator. This feature is typically used in Food retail application. MTR is generally used with variable speed compressors. This feature will control the evaporating temperature in a smooth way to ensure a stable food temperature.
Maximum Operating Pressure (MOP)	In order to reduce the strain on the compressor, a maximum operating pressure is set. If the pressure comes above this limit the controller will control the valve to provide a lower pressure instead of a low superheat.
Low Operating Pressure (LOP)	This feature which is also known as Cold start feature that allows applications such as heat pumps to operate at lower ambient conditions in order to prevent compressor from stopping due to low suction pressure in the start up phase.
Superheat close	When the superheat is below a set minimum value, the valve will close faster in order to protect the compressor from the risk of getting liquid in the suction line and bring the superheat back to superheat reference.
High Condensing temperature protection (HCTP)	High condensing temperature protection will make sure that the load on the condenser is reduced in case a too high condensing temperature is reached. This is done by limiting the valve opening degree.
Fast Start up	In some applications, it is necessary to quickly open an EEV valve when compressor turns ON to prevent too low suction pressure as well as for faster stabilization of superheat or temperature set point. This can be ensured by setting either P-control, Start opening degree with protection or Fixed opening degree without protection. This start up condition is kept until the start time expire or superheat reaches at setpoint.
Forced opening during OFF / (Bleed function)	In some applications valve must remain open when the controller is OFF. This can be done by setting a fixed opening degree. When normal control is switched OFF using a main switch, the valve will keep the defined opening degree.
Defrost sequence	The controller does not itself handle defrost of the evaporator. It is however possible to enter a special defrost sequence which will overrule the normal control of the valve.
Failsafe operation	During operation, if sensors error occurs, the valve position can be set to full close, fixed opening degree or average calculated OD as required.
Lack of Valve Capacity	A function is provided to indicate lack of valve capacity or loss of refrigerant charge. This is only indicated by setting an alarm. No special action is performed by the controller.
Wizard tool	The wizard tool will guide the user to set up the controller in a fast and easy way. The controller will then be loaded with the suitable PI values as per defined application and operating conditions.

3.3 Typical features used in various applications

Feature	Detail	Driver		Controller					
		Via Analog Signal	Via RS485 RTU	Chiller (Cooling only)	Reversible Chillers (Air / Water)	Reversible Heat pump	AC Air Handler	Cold Room Standalone	Multi evap on compress or pack

Hardware Features

Data Comm. MODbus / CAN				●						
-------------------------	--	--	--	---	--	--	--	--	--	--

Inputs/ Outputs

Temperature sensor	S2			●	●	●	●	●	●
	S3			○	●				○
	S4					●			○
Pressure sensor	Po			●	●	●	●	●	●
	P1					●		●	
External Reference (Driver functionality)	4 – 20 mA / 0 – 20 mA 0 – 10 V / 1 – 5 V	●							
Digital Input	DI1- injection control ON/OFF			●	●	●	●	●	●

Digital out: relay	Alarm			○	○	○	○	○	○
	NC function				○			●	●

Software features

Thermostat Control Cut-in / cut out								●	●
MTR	<i>Only work if condenser unit have variable capacity</i>							●	●
External reference	SH reference	●	●	○	○	○	○	●	●
	OD request	●	●						
	Temperature reference	●	●					●	●
Superheat regulation	Compressor feed forward (via modbus)			○	○	○	○		
SH Reference method	MSS			●	○	●		●	●
	Fixed			○	○	○	○	○	
	Loadap			○	●			●	●
	Delta temp (S3-T0) <i>(air cooled system with Finn and tube evap.)</i>			●	●				
Startup	Fixed OD and Time								
	Fixed OD and time with protection			○	○	○	○	○	○
	P-control			●	●	●	●	●	●
Limiter/Protection	MOP							●	
	LOP					●			
	S4 min								●
	SH close			●	●	●	●	●	●
Force OD during stop / standby					●	●			
Defrost	Start / stop via DI or bus				●			●	
Heat pump focus	High condensing temperature protection							●	
	Heat / cool select via bus or DI					●			

Advance feature

Fail safe operation	If S2 / S3 error occurs, select action			●	●	●	●	●	●
Sharing control signals	Temp. and pressure			○	○	○	○	○	○

- Typical used features
- Applications depended

4.0 Specification
4.1 General specification

Feature	Description
Power supply	Galvanic isolation by switch mode power supply Input voltage rating (AC): 24 V AC \pm 20 % (min.19.2 V AC - max. 28.8 V AC) Input frequency (AC): 50 / 60 Hz Input voltage rating (DC): 24 V DC (min. 20 - max. 40 V DC) Provides 5 W at 5 V and 15 V outputs isolated from the 24 V input Insulation between power supply and the extra-low voltage
Power Consumption	Total Power consumption with following valve in operation and MMIGRS connected to the controller: CCMT 16 - CCMT 42: 15VA / 10W ETS 6: 11 VA / 7.5W ETS 12C - ETS 100C: 20VA / 14W KVS C: 20VA / 14W ETS 12.5 - ETS 400 7 VA / 5W CCMT 2 - CCMT 8 7 VA / 5W CTR 20: 7 VA / 5W
Plastic Housing	DIN rail mounting complying with EN 50022 Self-extinguishing V0 according to IEC 60695-11-10 and glowing / hot wire test at 960 °C according to IEC 60695-2-12 Material used for Enclosure are UL94-V0 and RoHS compliant Ball test: 125 °C according to IEC 60730-1 Leakage current: \geq 250 V according to IEC 60112
Connectors	Plug able Screw connector Pitch 3.5 mm, relay and power connector Pitch 5 mm, CAN MMI: Modular Jack 6P4C Material used for connectors are RoHS and UL approved
Operating conditions	-20 – 60 °C, 90% RH non-condensing
Storage / Transport conditions	-30 – 80 °C, 90% RH non-condensing
Vibration and shock	According to IEC 60068-2-27 Ea
Integration	In Class I and / or II appliances
Index of protection	IP40 only on the front cover
PCB protection	None (no conformal coating)
Period of electric stress across insulating parts	Long
Resistance to heat and fire	Category D
Immunity against voltage surges	Category II
Software class and structure	Class A
Approvals	CE compliance: This product is designed to comply with the following EU standards: <ul style="list-style-type: none"> • Low voltage guideline: 2014/35/EU • Electromagnetic compatibility EMC: 2014/30/EU and with the following norms: <ul style="list-style-type: none"> – EN61000-6-1. EN61000-6-3 (immunity for residential, commercial and light-industrial environments) – EN61000-6-2. EN61000-6-4 (immunity and emission standard for industrial environments) – EN60730 (Automatic electrical controls for household and similar use) RoHS compliance to 2011/65/EU and no components from negative list acc. to 500B0751

4.2 Electrical specification

Feature	Type	Description
Protection	Short Circuit	Motor driver: dissipative over current protection
	Over voltage	Analog input: current limit and internal clamp diode Digital input: current limit and internal clamp diode Communication: transceiver IC
	Over temperature	Motor driver: thermal shutdown at 150 °C

4.3 Inputs / outputs

I/O	TYPE	SPECIFICATIONS
Analog inputs		Max. 15 V input voltage. Do not connect voltage sources without current limitation (overall 80 mA) to analog inputs while unit is not powered. Open circuit HW diagnostics available for voltage input on: AI3, AI4 (EKE 1C) AI4 (EKE 1A and EKE 1B).
	0 – 5 V	EKE 1C, AI3, AI4, and EKE 1A/EKE1B, AI3. Accuracy ± 40 mV, resolution 1.2 mV.
	0 – 10 V	EKE 1C, AI3, AI4, and EKE 1A/EKE 1B, AI4. Accuracy ± 50 mV, resolution 2.5 mV.
	0 – 20 mA (EKE 1C only)	Accuracy ± 100 µA, resolution 10 µA. Input resistance: <100 Ω
	NTC Sensor	NTC temperature probes: 10 kΩ at 25 °C range: 300 kΩ to 100 Ω Accuracy: 50 – 120 °C: 1.5 K, -40 – 50 °C: 0.4 K, 0 °C: 0.2 K Resolution: ≤ 0.1 K, ≤ 0.3 K (EKE 1C, AI5)
	Pt1000 sensor	Range: 723 Ω to 1684 Ω Accuracy: ≤ 0.5 K Resolution: ≤ 0.1K
	Pressure sensor	Type: Ratiometric - Accuracy: 1.6 % - Range: 0.5 – 4.5 V - Resolution: 1.2 mV - Supply voltage: 5 V DC / 15 mA, overload protection approximately 150 mA
Digital Input (DI)	Voltage free contacts	Steady current of 1 mA (EKE 1C only). A cut-in input will activate a function. Cleaning current of 100 mA at 15 V DC. On: RIL ≤ 300 Ω . Off: RIH ≥ 3.5 kΩ. No destructive if Vbat + is connected to DI (only for DI on bottom pcb). Min. pulse time 64 ms.
Digital output (DO1)	SPDT Relay	Reinforced Insulation between coils and contact (OV cat. II) Normally open: 3A GP, 2.2 FLA/13.2 LRA, 1/6 hp, PD 220 VA, 250 V AC, 100 k cycle Normally open: 3 FLA/18 LRA, 1/10 hp, PD 150 VA, 125 V AC, 100 k cycle Normally closed: 3A General purpose, 250 V AC, 100 k cycle
Stepper motor	Bipolar and unipolar stepper motor output:	- Danfoss ETS / KVS / ETS C / KVS C / CCMT 2 – CCMT 42 / CTR Valves (green, red, black, white) - ETS 6 / CCMT 0 / CCMT 1 (black, red, yellow, orange) Other Valves: - speed 10 - 400 pps - drive mode 1/8 microstep - max. peak phase current: 1.2 A (848 mA RMS) - max. drive voltage 40 V - max. output power 12 W
Battery backup		VBATT: 18 – 24 V DC: Leakage: <15 µA @30 V DC Optional: critical low alarm below 12V Optional: low alarm at 17 V, high voltage alarm at 27 V The valve will not close at power fail if voltage is higher than 27 V Required power to do 1 closing of stepper valve: ETS 6: 110 J / 30 VmAh ETS 12.5 - ETS 400: 60 J / 17 VmAh KVS 15 / KVS 42: 60 J / 17 VmAh ETS 12C - ETS 100C: 55 J / 15 VmAh KVS 2C / KVS 5C: 55 J / 15 VmAh CCMT 2 - CCMT 8: 60 J / 17 VmAh CCMT 16 - CCMT 42: 175 J / 49 VmAh CTR 20: 60 J / 17 VmAh Either Power voltage or Battery can be shared between different units.
Communication	RS-485 RTU	Galvanic isolation. No Built in termination. Supported commands with max. of 50 ms response time : 0 x 03, 0 x 04, 0 x 06.
	CAN	4 ways terminal block and RJ connector to directly connect and supply a user interface MMI. For Danfoss controllers only.

Warning!

Battery Backup does not generate power to recharge the connected device to its terminal.

Do not connect external power supply to the digital input DI terminals, else it will damage the controller.

The relays cannot be used for the direct connection of capacitive loads such as LEDs and ON/OFF control of EC motors. All loads with a switch mode power supply must be connected with a suitable contactor or similar.

5.0 Connectors

A. EKE 1A connectors

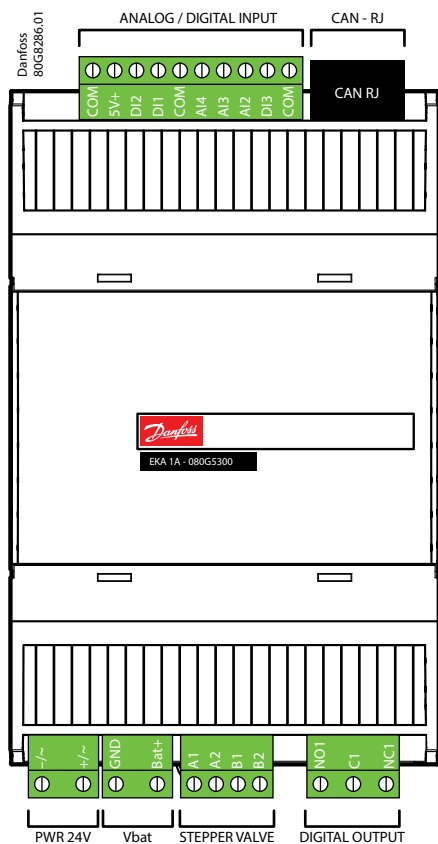

B. EKE 1B connectors

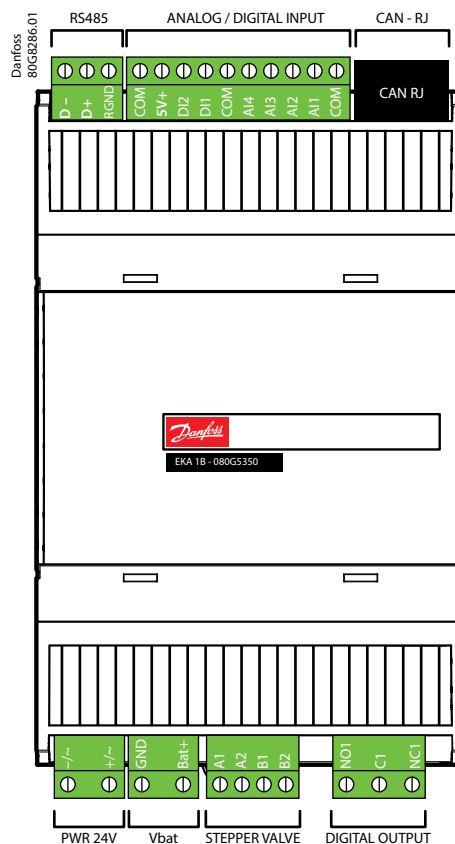

C.1 EKE 1C connectors: Back

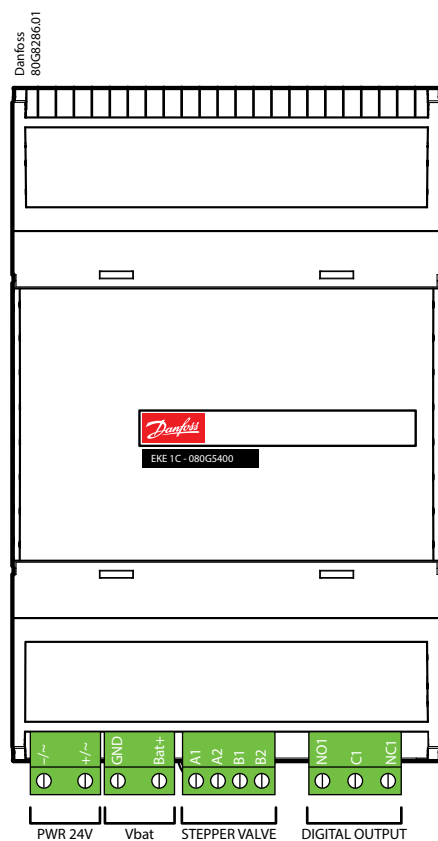

C.2 EKE 1C connectors: Front

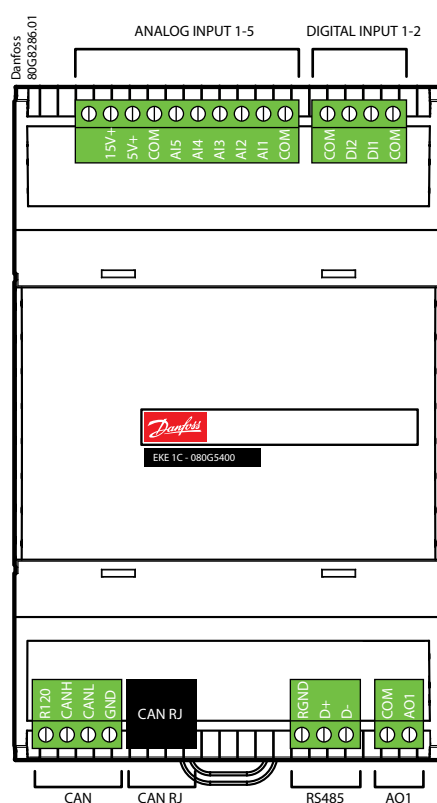

5.1 EKE 1A connection overview

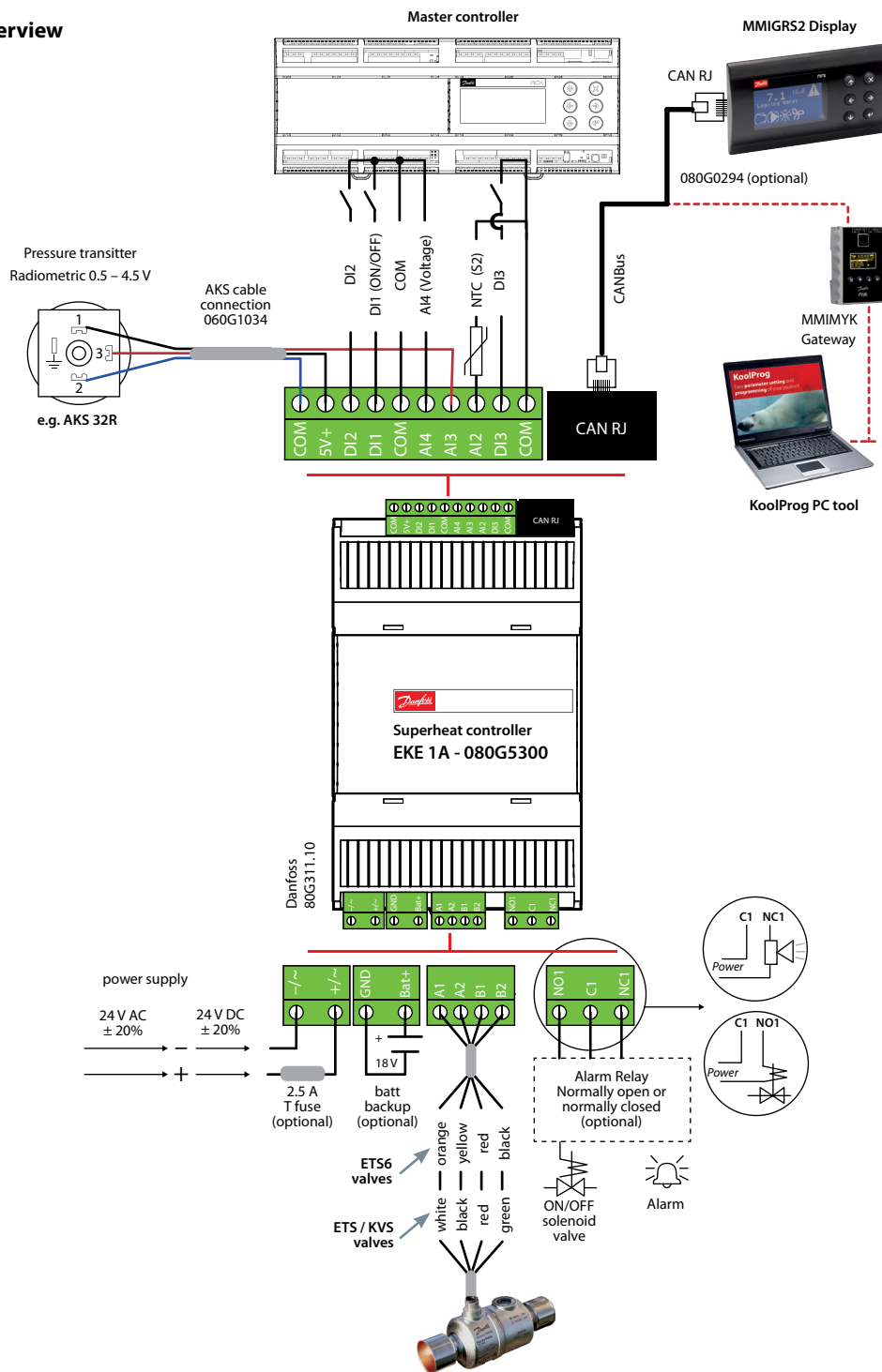

Analog / Digital input

1: COM	Common	
2: DI3	Digital input 3	Software configurable D1
3: AI2	Analog inputs NTC 10K	S2
4: AI3	Analog inputs 0 – 5 V / Radiometric pressure transmitter	Pe
5: AI4	Analog inputs 0 – 10 V	External Reference signal
6: COM	Common	
7: DI1	Digital input 1	Main switch (hardware)
8: DI2	Digital input 2	Software configurable DI
9: 5V+	Power output for Radiometric pressure transmitter 0 – 5 V	
10: COM	Common	

5.2 EKE 1B connection overview

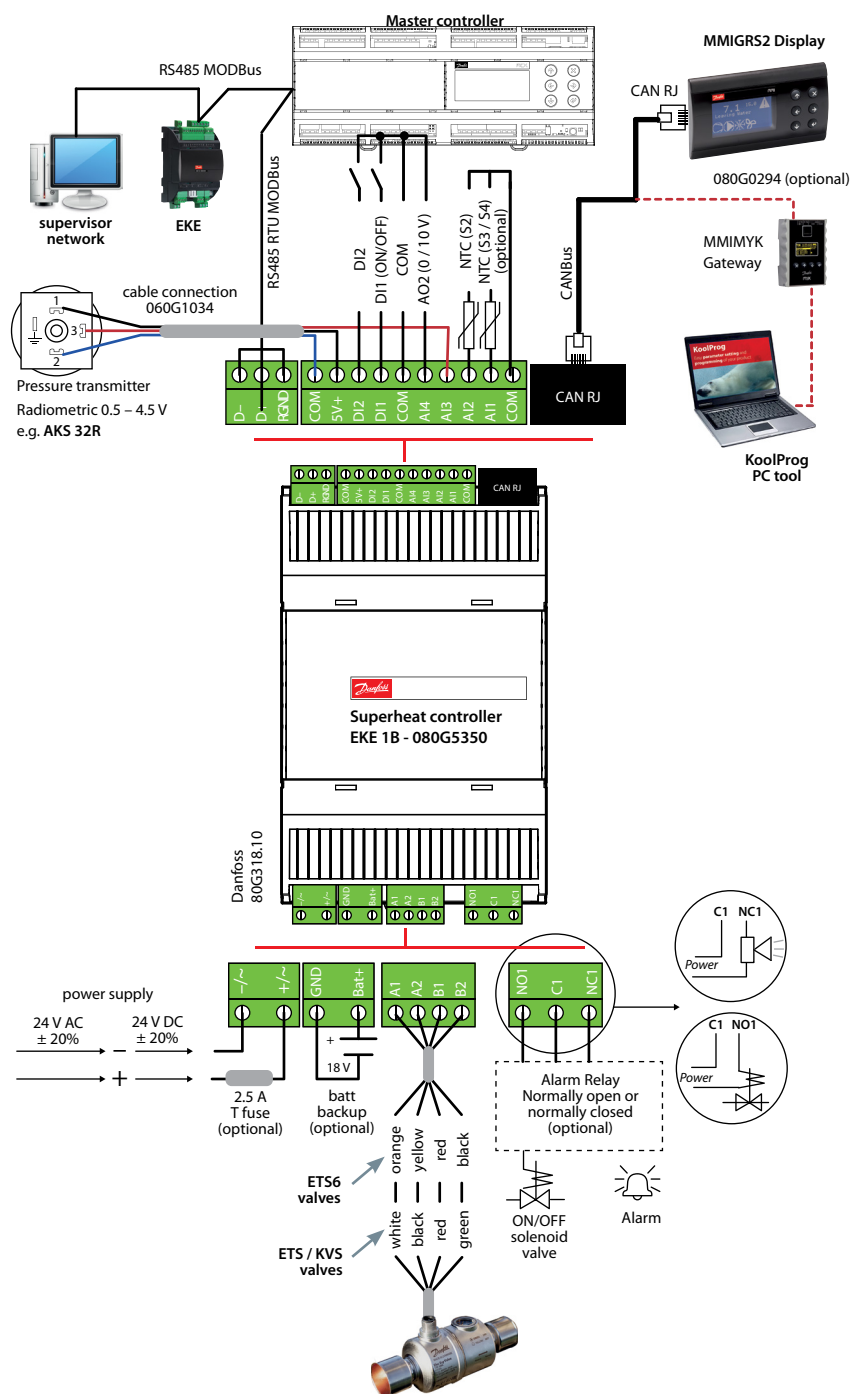

Analog / Digital input

1: COM	Common	
2: AI1	Analog inputs NTC 10K	S3/S4 selectable via software
3: AI2	Analog inputs NTC 10K	S2
4: AI3	Analog inputs 0 – 5 V / Ratiometric pressure transmitter	Pe
5: AI4	Analog inputs 0 – 10 V	Ext. Ref. voltage signal
6: COM	Common	
7: DI1	Digital input 1	Main switch (hardware)
8: DI2	Digital input 2	Software configurable DI
9: 5V+	Power output for Ratiometric pressure transmitter 0 – 5V	
10: COM	Common	

5.3.1 EKE 1C - Front board connection overview

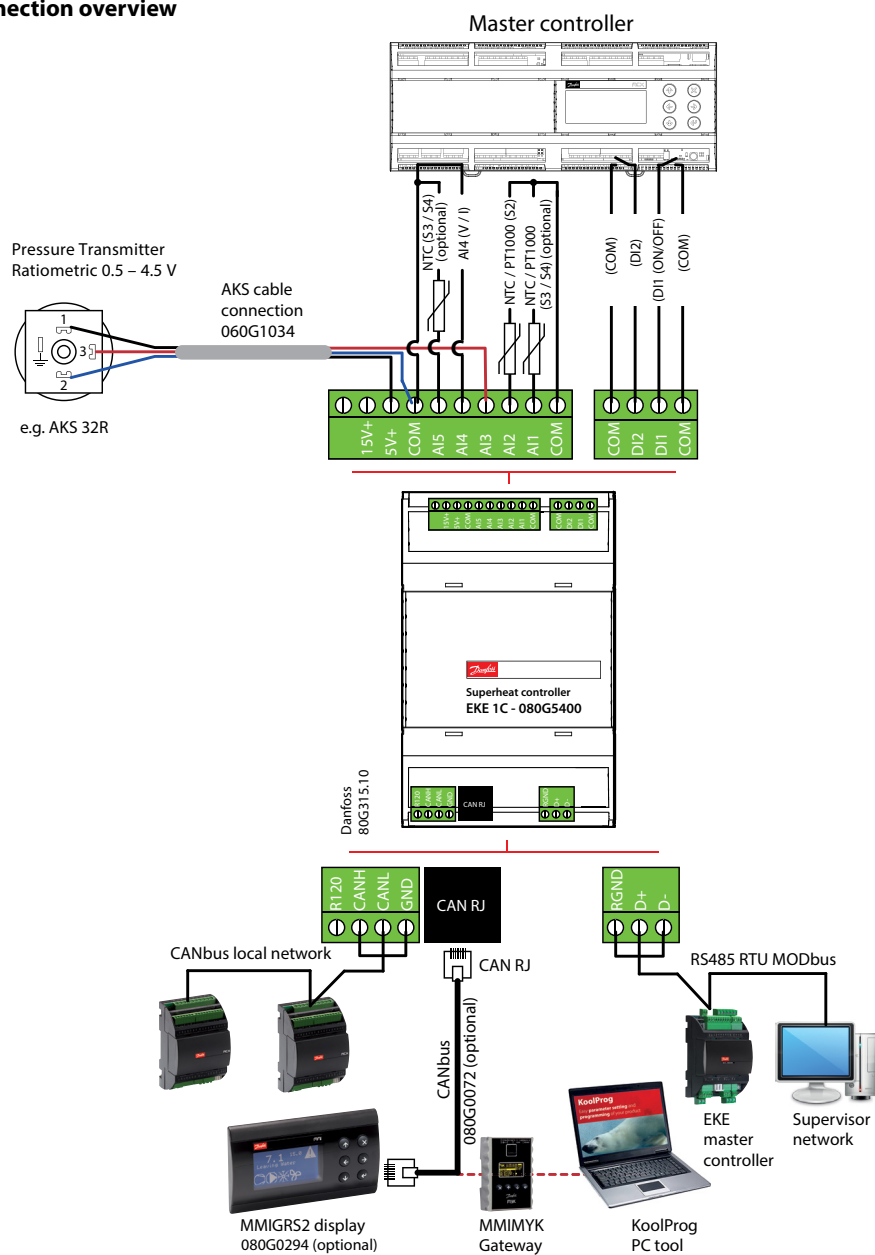

Analog / Digital input

COM	Common	
AI1	Analog inputs temperature NTC 10K / PT1000	S3/S4 selectable via software
AI2	Analog inputs temperature NTC 10K / PT1000	S2
AI3	Analog inputs voltage / current	Pe
AI4	Analog inputs voltage / current	Ext. Ref. or Pc
AI5	Analog inputs NTC temperature	S3/S4 selectable via software
COM	Common	
5V+	Power outputs for Ratiometric pressure transmitter 0 – 5V	
15V+	Power output for current signal pressure transmitter	
24V+	Not used in EKE 1C	
AO1	Not used in EKE 1C	
DI1	Digital input 1	Main switch (hardware)
DI2	Digital input 2	Software configurable DI

Connection for 4 - 20 mA pressure Transmitter

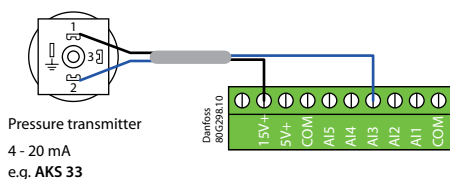

EKE 1C analog input at terminal 1 - 5. For other transmitter types, check the following table.

Note:
EKE 1A/1B only supports ratiometric 0.5 to 4.5V pressure transmitter.

EKE 1C supports wide range of pressure transmitter, make sure that the proper power supply terminals for the selected transmitter is connected according to the guidelines provided below.

User selection EKE connection	Signal	EKE connection
Not Used	-	-
AKS 32R	Ratiometric 10-90%	5V supply from EKE
AKS 32 1-5V	1 - 5V	15V supply from EKE
AKS 32 1-6V	1 - 6V	15V supply from EKE
AKS 32 0-10V	0 - 10V	15V supply from EKE
AKS 33	4 - 20 mA	15V supply from EKE
112CP(Sensata)	Ratiometric 10 - 90%	5V supply from EKE
XSK (Saginomiya)	4 - 20 mA	15V supply from EKE
NSK (Saginomiya)	Ratiometric 10 - 90%, 0.5 to 4.5 V	5V supply from EKE
OEM Ratio	Defined by the parameters	5V supply from EKE
OEM Voltage	Defined by the parameters	15V supply from EKE
OEM Current	Defined by the parameters	15V supply from EKE

5.3.2 EKE 1C - Back board connection overview

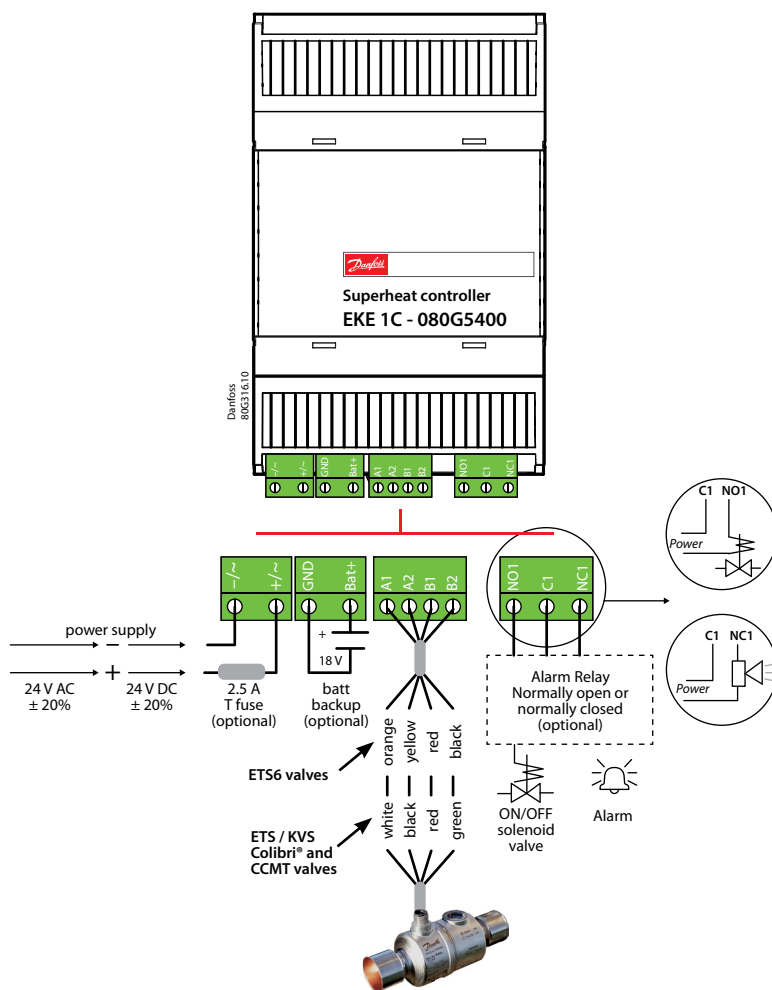

6.0 Installation

This section describes the typical installation in brief, for detail please refer to the EKE Installation guide

6.1 General installation



Note:
Always install the Electronic Sensors and expansion valve of suitable capacity as close to the evaporator as possible. Under size or over sized valve in the system may impact the performance of the system. Sensors away for evaporator may impact the precision and the system performance.

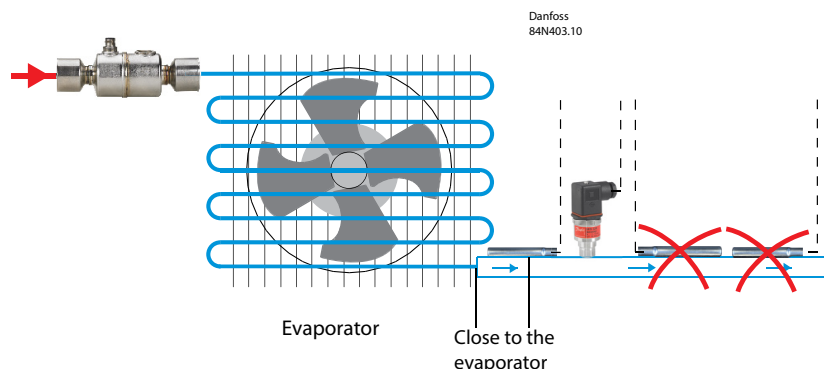

6.2 Sensor mounting

6.2.1 Temperature sensor



- Note:**
- Mount sensor on a clean surface without any paints.
 - Remember to put on heat conducting paste and insulate the sensor.
 - Sensor mounting max. 5 cm from the outlet of the evaporator to get the precise measurements.
 - Physical temperature sensor can't be shared.

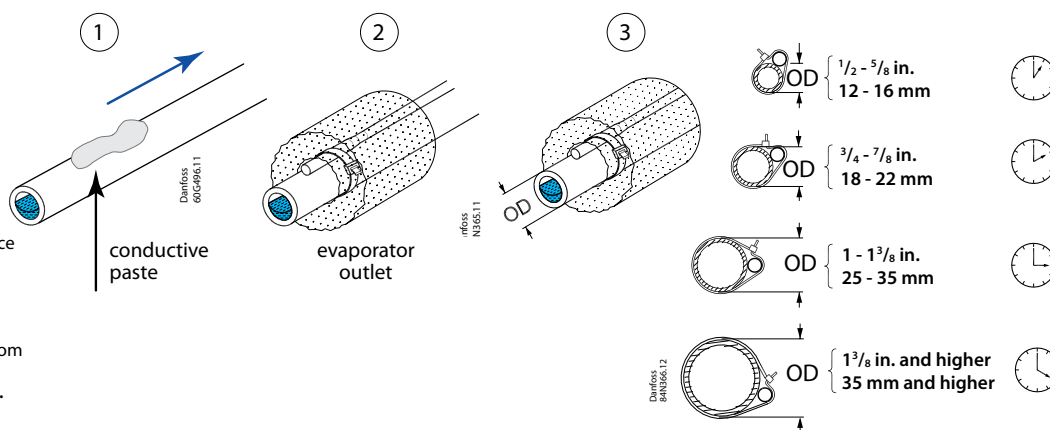

6.2.2 Pressure transmitter mounting

Installation of the pressure transmitter is less critical. but mounting of pressure transmitter should be closer to the temperature sensor right after the evaporator and with its head in "upright position".

6.2.3 Sharing pressure sensor

In EKE 1A and EKE 1B, it is allowed to share one ratiometric pressure transmitter between up to five controllers.

If several evaporators are sharing the same suction line, the signal from the pressure transmitter can be used by max of 5 controllers as shown below. In order to get a correct acquisition on all the units all the three wires (GND, 5V and transmitter signal, output) must be routed to every unit.

In EKE 1C, a physical pressure transmitter is not allowed to share between multiple EKEs, however the pressure signal values can be shared via CANBus



Note:
In EKE 1C, physical pressure can not be shared. Pressure values can be shared via CANBus only

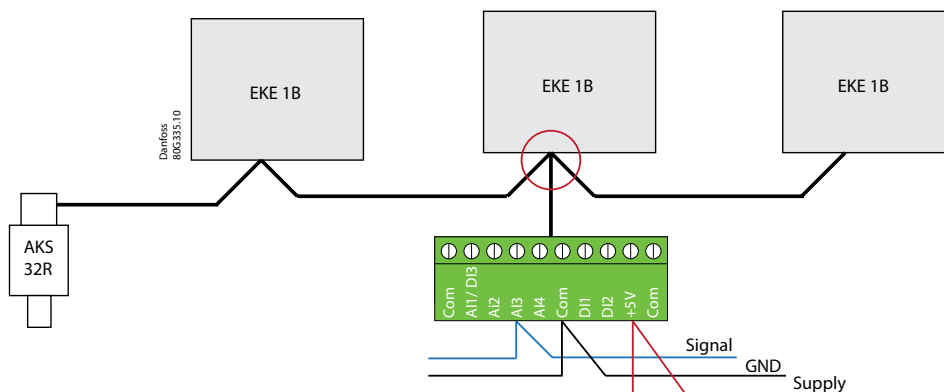

6.2.4 Pressure/ Temperature signal sharing in EKE 1C via CanBus

In EKE 1C, Signal sharing is possible via CANbus, Signal will be broadcasted once per second to all controllers by CAN serial line. The following parameters enable/disable broadcasting of local signals:

- [G012 - Signal sharing Pe]
- [G013 - Signal sharing Pc]
- [G014 - Signal sharing S3]

If two or more sensors are connected to same sharing group the controller which start up as the first one will broadcast the signal, other controllers will ignore broadcasted signal. If the receiving controllers has not received a shared signal from another controller for 3 seconds (parameter G003 CAN bus min update interval) it will start broadcast the local sensor.

MASTER/SLAVE and I/O configuration via CANbus.

When more controllers are connected via CANbus each end of the bus must be terminated with a jumper between CANH and R120.



Note:
Broadcasting is not possible via Modbus. In case of Sensor error, broadcast will stop.

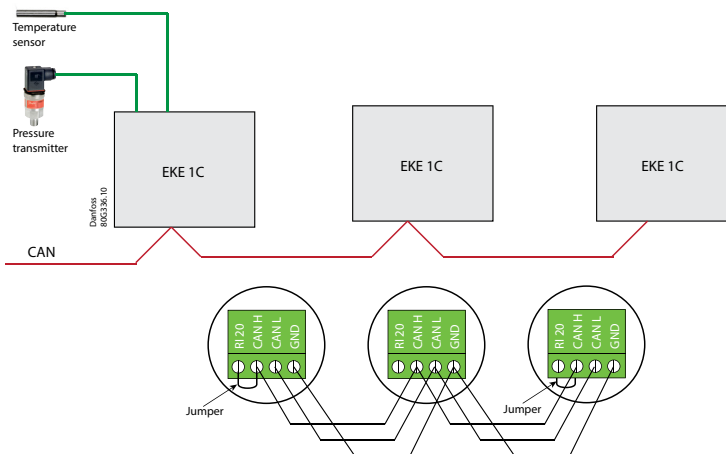

6.2.5 Using external signal values via communication

EKE 1B/1C controllers can read the external sensor values like Po, S2, S3 and S4 via bus communication. In some applications, the suction pressure and/or the refrigerant temperature on the evaporator outlet, is measured by a system controller. This is often the case if the suction pressure is used to trigger low temperature/pressure alarms by the systems main controller. In these cases the sensors can be omitted from EKE, and the sensor values can be received via modbus instead. This requires that the systems main controller continuously transmits these values to EKE, If no new sensor value is received within defined MODbus time interval in seconds i.e G004 of the last transmission, the EKE will raise sensor alarm which will stop the regulation.

Example: The suction gas temperature S2 and the evaporator pressure Pe can be set by activating bus shared sensor configuration registers i.e "I040 = 5" and "I044 = 14" respectively.



Note:
External pressure values must be scaled by X100 time and temperature values by X10 times before writing it on EKEs. Example: 8.4 bar gauge is written as 8400, and 2.4 deg C as 24 via bus



Note:
External signal value has to be update frequently, check parameter list for detail.

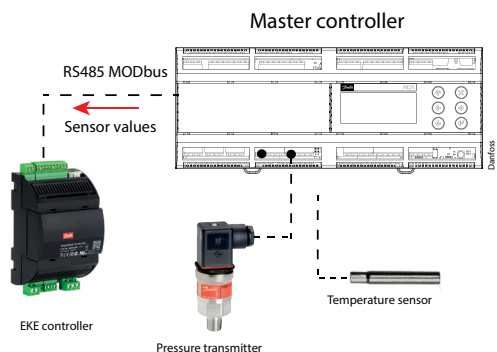

6.3 Sensor Correction

The input signal from all connected sensors can be corrected. A correction will only be necessary if the sensor cable is long and has a small cross-sectional area. All displays and functions will reflect the corrected value.

Regarding temperature sensor, PT1000 temperature sensor is sensitive with longer cable length and type. It is must to perform a sensor correction if the resistance of the temperature sensor deviates. Normally, 1 degree C corresponds to approximately 4 ohms.

6.4 Shared input signal

EKE accepts shared analogue voltage signal. Ext ref signal i.e 0 -10 V can also be shared in EKE 1A and 1B

6.5 Shared DI inputs

EKE controller is provided with voltage free contacts. DI terminals must not connect with external power supply. DI cannot be shared. If DI signal requires sharing, a work-around is to provide each DI with its own relay (or optocoupler). Relay (or optocoupler) output – which is connected to EKE1V DI and EKE1V COM - must withstand 100mA impulses at 15V.

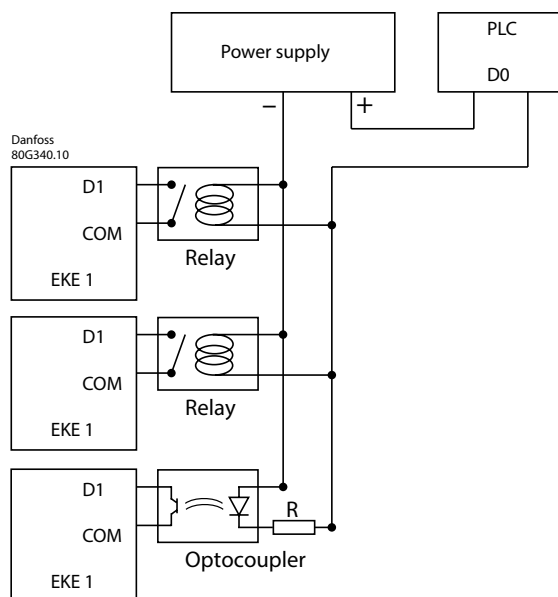

6.6 Sharing power supply and battery back up

The power supply of EKE is galvanically separated from the outputs. This gives a benefit for EKE to share common power supplies with multiple controllers.

Battery back up is an optional feature. If Battery backup is connected to EKE terminals, the EKE will close the stepper motor if the controller loses its supply voltage. The battery voltage must not be connected from main power supply connected to EKE. A battery voltage lower than 16.5 V and higher than 27V will trigger the battery alarm.

The power supply from the common backup power source can be shared with multiple EKE controllers, but make sure that the external power supply has enough power Watt/VA to operate multiple controllers.

Warning:
The battery voltage must not be connected from terminals of EKE main power supply.

A special attention is needed on sharing both external power supply as well as battery backup. Strictly speaking, it is not allowed to shared AC power supply and DC backup battery simultaneously with multiple controllers. In case both DC power supply and battery are shared between several units, the safest setup is to have the negative poles of battery and power input shorted together at each unit. Such solution requires EMC test to be conducted on the final equipment by customer.

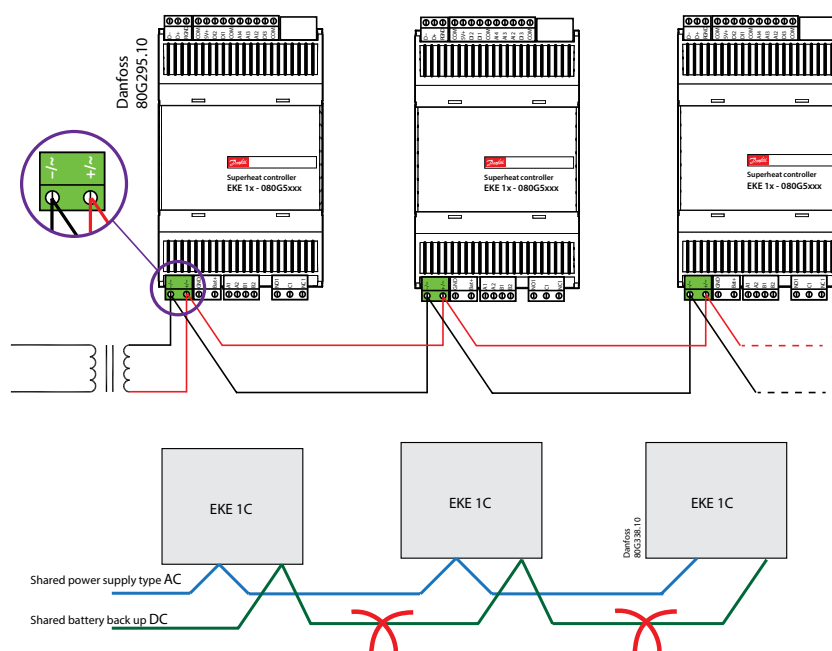

Warning:
It is strictly not allowed to shared AC power supply and DC backup battery simultaneously with multiple controllers

6.7 Cabling

Separate the sensor and digital input cables as much as possible (at least 10 cm) from the power cables to the loads to avoid possible electromagnetic disturbance. Use separate cable trays. Long DI input should be avoided.

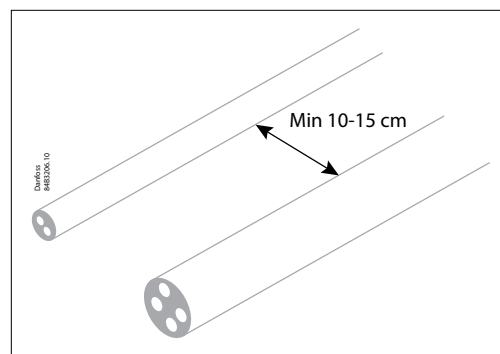

Note:
Never lay power cables and probe cables in the same conduits (including those in the electrical panels)

6.7.1 Cable length

EKE controller supports the following max. cable length.

	Cable length	Wire size (Min. / Max.)
Analog inputs (Current/Voltage)	max. 10 m	0.14 / 1.5 mm ²
Temperature sensor	max. 10 m	-
Stepper valve connection	max. 30 m*	0.14 / 1.5 mm ²
Power supply	max. 5 m	0.2 / 2.5 mm ²
Digital input	max. 10 m	0.14 / 1.5 mm ²
Digital output	-	0.2 / 2.5 mm ²
Digital MMI	max. 3 m over CAN RJ	-
Communication bus	max. 1000 m	0.14 / 1.5 mm ²

*For longer cable refer section "For non Danfoss M12 cable" and Parameter setting for long M12 cable.

For non Danfoss M12 cable

Guideline for long M12 cables on Danfoss stepper motor valves

- Long cables will lead to degradation of performance.
- You can overcome this degradation by changing the settings for the valve driver. This guideline is based on the cable type being the same type as the standard Danfoss stepper motor cable.

Recommended wire size and cable distance (twisted pair) between EKE controller and stepper motor valve.			
Cable length	1 m – 15 m	15 m – 30 m	30 m – 50 m
Wire diameter	0.52 / 0.33 mm ² 20 / 22 AWG	Min. 0.52 mm ² 20 AWG	Min. 0.82 mm ² 18 AWG

Apart from the cable selection, it is suggested to do the following parameter changes to the given valves.

Parameter setting for long M12 cable.

Note:
For longer M12 cable than 15m, it is must to set Danfoss valve as user defined valve and do necessary parameter settlings.

Tips:
First select the correct Danfoss valve to get the profile loaded, then select the user defined valve to increase the current value.

Product	0m - 15 m cable	15m - 30 m cable	30m - 50 m cable
	Update following parameter		
ETS 12C - ETS 100C KVS 2C - KVS 5C	Use default values	I028 Valve drive current = 925mA peak	I028 Valve drive current = 1000mA peak I065 Valve duty cycle = 90 %
ETS 12.5 - ETS 400 KVS 15 - KVS 42 CTR 20 CCMT 2 - CCMT 8 CCM 10 - CCM 40	Use default values	I028 Valve drive current = 200 mA peak	I028 Valve drive current = 300mA peak
ETS 6	Use default values	I028 Valve drive current = 270mA peak	I028 Valve drive current = 350mA peak
CCMT 0	Use default values	I028 Valve drive current = 270mA peak	I028 Valve drive current = 350mA peak
CCMT 1	Use default values	I028 Valve drive current = 400mA peak	I028 Valve drive current = 500mA peak
CCMT 16 - CCMT 42	Use default values	I028 Valve drive current = 450mA peak	I028 Valve drive current = 500mA peak

7.0 Stepper motor valve

EKE controller can driver all stepper motor valve from Danfoss. The connection of the Danfoss stepper motor should be done as shown on the connection diagram/table. For stepper motor valve from other manufactures, it is necessary to get the right electrical connection information from valve manufacturer as described in the following section.

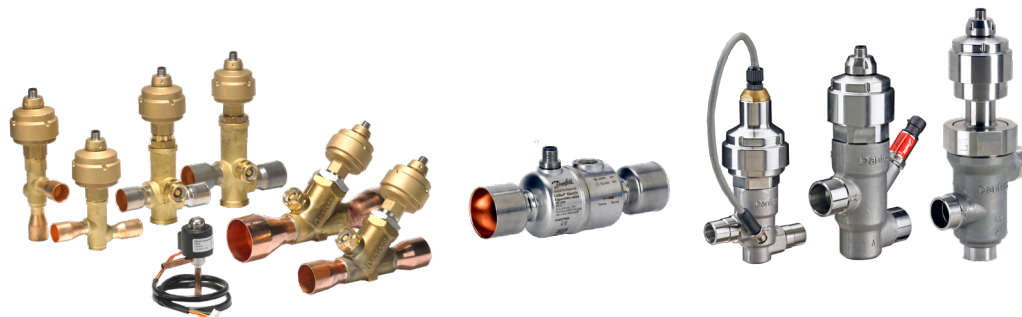

*ETS Electric expansion valves
KVS Electric regulating valves*

*ETS Colibri® Electric expansion valves
KVS Colibri® Electric regulating valves*

*CCM Electric regulating valves
CCMT Electric regulating valves
CTR Electric 3-way valve*

7.1

Guideline for long M12 cables on Danfoss stepper motor valves

- Long cables will lead to degradation of performance.
- You can overcome this degradation by changing the settings for the valve driver.

For the detailed guideline and parameter settings please refer to the installation guide section: For non Danfoss M12 cable.

7.2 Danfoss valve connection

Valve Cable Connection

CCM / CCMT / CTR / ETS Colibri® / KVS Colibri® / ETS/KVS

Danfoss M12 Cable	White	Black	Red	Green
CCM/ETS/KVS Pins	3	4	1	2
CCMT/CTR/ETS Colibri/KVS Colibri Pins	A1	A2	B1	B2
EKE terminals	A1	A2	B1	B2

ETS 6

Wire color	Orange	Yellow	RED	Black	Grey
EKE terminals	A1	A2	B1	B2	Not connected

7.3 Stepper motor valve parameters



Note:
For Danfoss Valve, It only requires to select the proper valve from default selection list. It will automatically load all other relevant valve parameters.

Change of valve type requires that the controller is in stopped state



Warning:
Modifying the Danfoss valve parameter will revert I067 – Valve Configuration to 1 i.e User Defined valve.



Note:
When the motor type is Unipolar the steps entered is half steps. Otherwise it is full steps

I067 – Valve Configuration

Danfoss stepper motor valve must be selected from Valve configuration list. On selecting the valve, the controller will automatically load pre-defined default values. The user is not required to set other stepper motor parameters for a selected valve from the valve configuration list.

User Defined valve

If a valve from other manufacturers is used, such valve can be defined as "User defined Valve" i.e I067 – Valve Configuration =1 and the following information will be required from the manufacturer for settings following stepper motor parameters.

I027 – Valve Motor Type

Define a type of motor used in the stepper valve (Unipolar/Bipolar). Selecting the motor type will set the required valve decay mode. Alternatively, you can also set valve decay mode parameter if you need more options. Avoid setting both Valve motor type and valve decay mode for a given valve at the same time.

I028 - Phase Current Peak /Valve drive current

The current applied to each phase of the stepper motor during actual valve movement. Verify the range against the stepper valve controller in the actual design. Please be aware that this value has to be set in a Peak value. Some valve manufacturers are using RMS current!

I077 Holding Current

The percent of the programmed Max Phase Current that should be applied to each phase of the stepper output when the valve is stationary. If required, this current ensures that the valve maintains its last programmed position.

I030 - Max Operating Steps /Total no of valve steps

The number of steps that correspond to a valve position of 100%. The total no of steps will vary according to the selected Valve motor type. For example ETS 6 has total number of 480 half steps on driving with half phase excitation whereas only 240 full steps on driving with Full phase excitation.

I031- Step Rate /Speed

The desired valve drive rate in steps per second. Please note that a higher valve speed will produce a lower torque. If the valve is used in system having high differential pressure, it is better to operate the valve with lower step rate.

[I032 - Valve Start Speed] (1-100% of Valve speed)

This is useful for high speed valve that runs at speed i.e 200 to 400 pps. This feature will limit starting speed of the valve in order to provide higher torque to the motor at start up and will prevent the valve from potential step loss. Refer to the diagram below for detail.

I062 - Valve Acceleration Current , I063 - Valve Acceleration Time

These features are used in the valve that runs at higher speed i.e 300 pps and above. Typically, at start up high torque is required to operate the valve. The high torque at start up can be maintain by using acceleration current as required. Following chart shows the relation between valve speed and valve current as well as the recommend percentage of acceleration current.

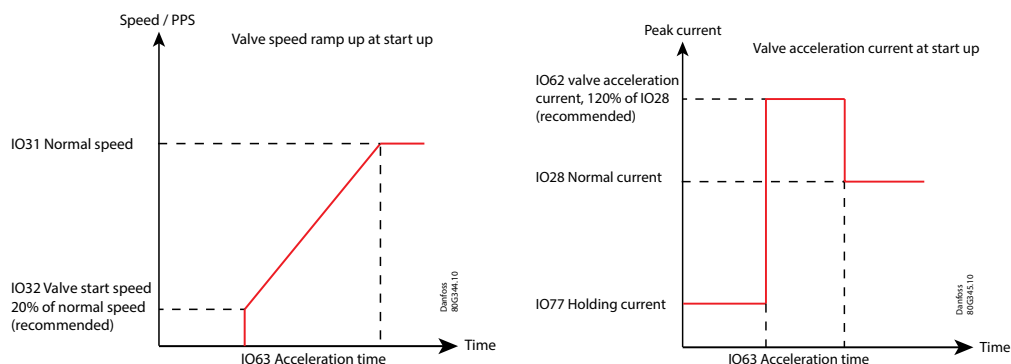

I064 – Valve step mode

Stepper motor can be driven with various step excitation method. The selection of the right method depends on the valve requirements as well as operating conditions of an application. The valves can be driven in full step 1/1, half step 1/2, or in microsteps (1/4, 1/8, 1/16). Danfoss recommends to use 1/8 stepping mode as this provides a good balance between torque and speed and ensures smooth operation.

Full stepping mode 1/1, provides higher torque which is needed for application having high differential pressure, but high rate of acceleration increases the risk of lost steps. Half step excitation 1/2, is generally use for Unipolar valves. and microstepping 1/16 is used where smooth operation is needed. This will provide a bit lower start torque.

I065 – Valve duty cycle

The required valve duty cycle can be set between 5-100% using this parameter. Some valves requires higher duty cycle when operating at lower fluid temperature. Reduce the duty cycle for the valve that uses high fluid temperature.

I070 – Start Backlash

The parameter defines the operation of the start backlash function. The valve will normally open from this point onwards.

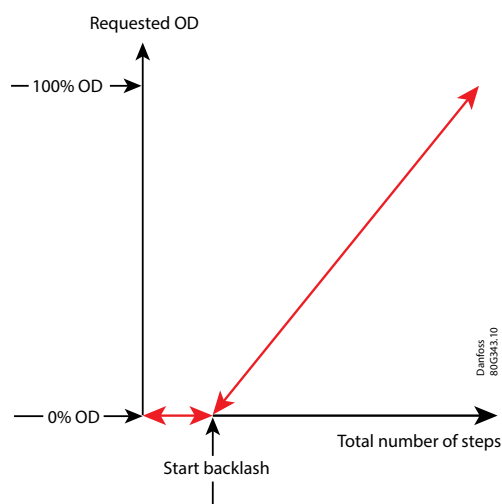
I071 - Backlash compensation (Hysteresis)

The number of steps needed to correct for mechanical hysteresis when a reduction gear is part of the valve design. This adjustment is only applied if an additional opening of the valve is requested. To ensure that the backlash is at a minimum, the motor will drive a number of extra steps every time the direction of the motor is changed.

I076 Valve excitation time after stop

The time that the drive current is applied after the motor has stopped before going to holding current. This will make sure that the valve has achieved the final position before going to holding current.

7.4 Useful Valve parameters for various application

The following valve parameters can be used in various application as needed.

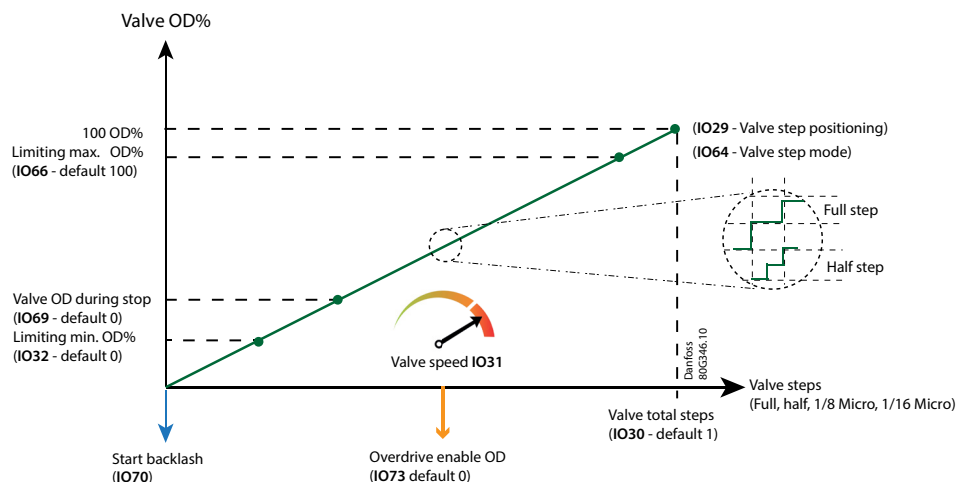

IO61 – Valve emergency speed

During power failure conditions, the valve can be driven at higher speed if required to close if faster. To run this feature, it is require to connect EKE with backup battery.

IO66 –Minimum OD limit

When required, the valve minimum OD can be set to a required minimum opening position, such feature is helpful where the system always requires some minimum flow. The minimum OD limit has effect in injection control mode only.

IO32 – Maximum OD limit

This is useful feature to limit the maximum OD of a oversized valve used in the system. By default the maximum OD of a valve is set at 100 OD%. This maximum OD % can be set to lower value if required. The maximum OD limit has effect in injection control mode only.

IO69 – Valve OD during stop

In some applications valve must remain open when the controller is OFF. This can be done by setting a fixed opening degree. When normal control is switched OFF using a main switch, the valve will keep the defined opening degree. This feature is also known as Forced opening during OFF / (Bleed function).

IO68 – Valve neutral Zone

EKE controller has a complex algorithm implemented to handle oscillation issues related to output valve OD by defining some neutral zone. In neutral zone, the valve will not move untill it overcomes the definite variation in the valve opening degree .

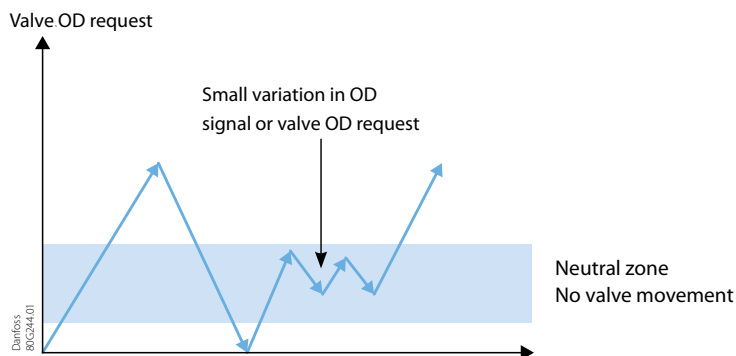

For the default neutral zone of 0.5 % hysteresis, the valve will not move if it is unable to receive the higher variation than the set value. The benefit of using such techniques will not affect in the performance of the system but will reduce the problem related with the fluctuating signal, step loss and hysteresis in the valve.

Failsafe Position

During failsafe mode of operation (e.g. SH control sensor error or Thermostat sensor error) the valve position can be set to full close, fixed opening degree or average calculated OD. For detail check section Failsafe operation and parameter list under section control advance sub section Diagnostic SH and Emergency cooling.

8.0 Modbus communication

EKE	1A	1B	1C
Applicable	-	✓	✓

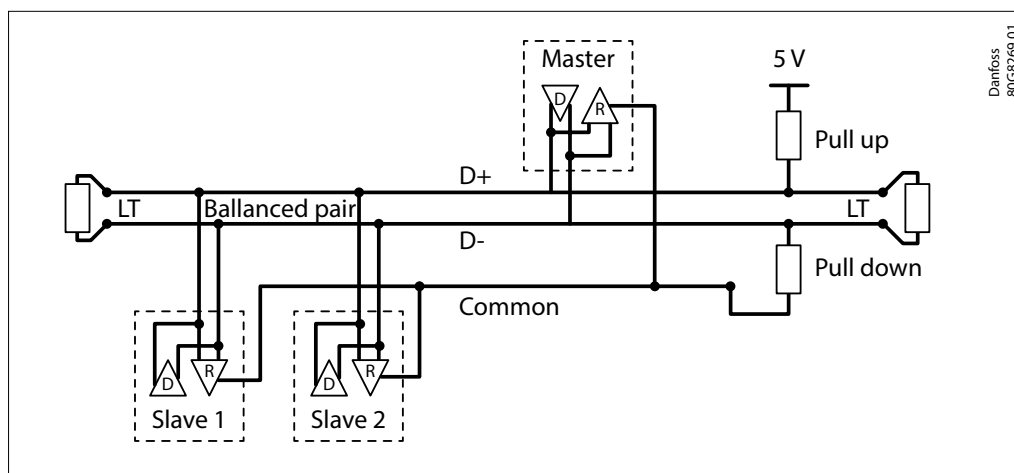

Details about the Modbus communication can be found in “EKD / EIM Data communication MODbus RS 485 RTU design guide”.

The brief on EKE MODbus RS – 485 RTU has been explained below.

EKE controller uses half duplex standard MODbus RTU protocol.

With the following defaults :19200 Baudrate, Even parity and one stop bit.

The default unit address is 1 which can be changed using parameter “is G001 Controller Adr”.

8.1 Modbus RTU setting

Data	Feature
Controller address (G001)	Range 1 - 120, default address 1
Modbus Baud Rate (G005)	1200, 2400, 4800, 9600, 14400, 19200, 28800, 38400 Default value: 19200
Modbus mode, selection (G008)	8N1, 8E1, 8O1 and 8N2

Note:
Default modbus setting:
19200 8E1

There must be always two terminations on the network, one at each bus end. The termination can be installed by connecting a 120 Ohm resistor between D+ and D- for RS-485. Here is shown a picture of how a Modbus network is typically terminated. The resistors are in this picture called LT (Line Termination) and are typically 120 Ohm. The pull up and pull down are usually built into the master on the Modbus. They are not built in Danfoss EKE controllers.

8.2 Addressing convention

In EKE controllers, when addressing holding registers on Modbus, the range of valid addresses is 0-65535 (0x0000 to 0xFFFF). In this convention the range of valid register numbers is 1-65536, and the register address 0 is referred to as register number 1.

Danfoss EKE follows this convention so when reading the PNU (Parameter Number) 117, the actual request asks for data from Address 116. So **address = PNU – 1**

Note:
Modbus address = PNU – 1

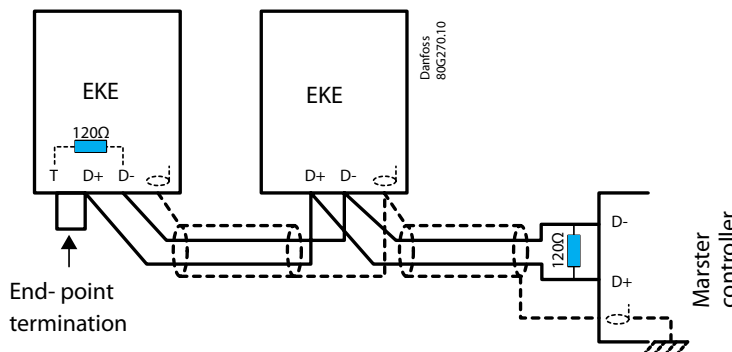

8.3 RS485 bus function codes overview

Function code	Function name	Function description
(0x03)	Read holding registers	This function code is used to read the contents of the contiguous block of holding registers in a remote device.
(0x06)	Write single register	This function code is used to write a single holding register in a remote device.
(0x10)	Write multiple registers	This function code is used to write a block of contiguous registers (1 to 123 registers) in a remote device.
(0x2B)	Read device identification	Support of mandatory information.

8.4 Example: MODBus communication

The following example illustrate the way of reading and writing the PNU numbers shown below

PNU	Parameter name
3006	R101 Temperature setpoint
3007	R001 Differential

Note:

In bus communication, only MET (SI) system can be used.
Metric unit (MET): temperature, temperature offset and pressure units in MMIGRS2 display °C, K and Bar Gauge respectively

Note:

setpoint needs to be scale by X10 . i.e 5 deg C =50 (HEX: 32)

PNU	Parameter name
3006	R101 Temperature setpoint
3007	R001 Differential

Function 03 read register

Example 1: Read 2 register from 3005 i.e 3005-3006, i.e PNU 3006-3007, from device address 1 (in blue)

TX: [01][03][0B][BD][00][02][56][0B]

RX: [01][03][04][00][1E][00][14][9A][3A]

Result

Read temperature setpoint and differential

PNU	Parameter name	Value
3006	R101 Temperature setpoint	30 (3.0)
3007	R001 Differential	20 (2.0)

Function 06 write register

Example 2: Write R101 Temperature set point to 5.0 (50 0x32)

TX: [01][06][0B][BD][00][32][9A][1F]

RX [01][06][0B][BD][00][32][9A][1F]

Slave acknowledge

Function 0x10 write multiple register

Example 3: Write R101 Temperature set point to 4.8 (48 0x30) and R001 Differential to 10.0 (100 0x64)

TX: [01][10][0B][BE][00][02][04][00][64][00][30][4B][AC]

RX: [01][10][0B][BE][00][02][23][C8]

Slave acknowledge

9.0 User interface: Display MMIGRS2

EKE	1A	1B	1C
Applicable	✓	✓	✓

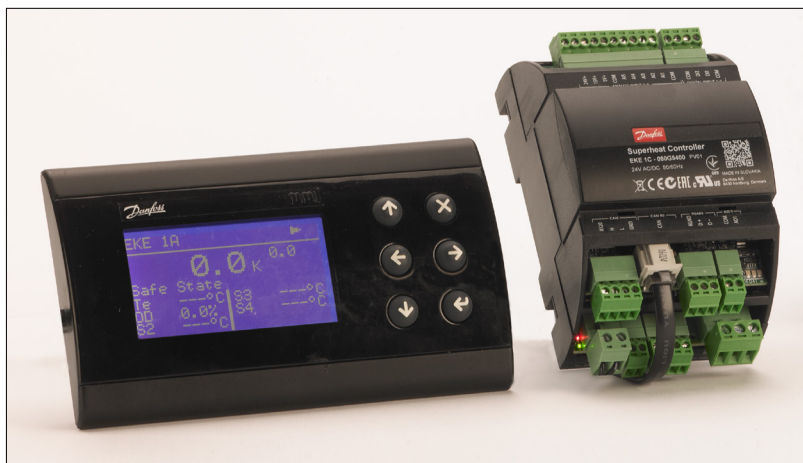

MMIGRS2 is a remote interface. It's fitted with a graphic display. The connection with each EKE controller is made through the CAN RJ or CANbus network. All the information about the user interface is loaded inside the EKE controller; that's why there is no need of programming the MMIGRS2 interface. MMIGRS2 is powered externally or from the controller which it is connected to and automatically shows its user interface. The menu displays are dynamic. A simple application with few connections will give a setup with few settings while application with many connections will give a setup with many settings.

9.1 Connection



Note: When MMI is not connected to EKE via telephone cable the autodetection feature of the EKE CAN address will not work. Therefore check the following MMIGRS2 setting:
 1) enter BIOS menu pressing and holding X + Enter keys for 5 s
 2) select "MCXselection" -> "Manual Mode" and set the CAN address of the EKE you wish to connect to.

CAN H-CAN R connection should be done only on the first and second element of the network.

CANbus requires both ends of the bus to be terminated by a 120 ohm resistor. EKE 1A and EKE 1B already include the termination. On EKE 1C and MMI, the termination must be included by shorting CAN R and CAN H with a wire.

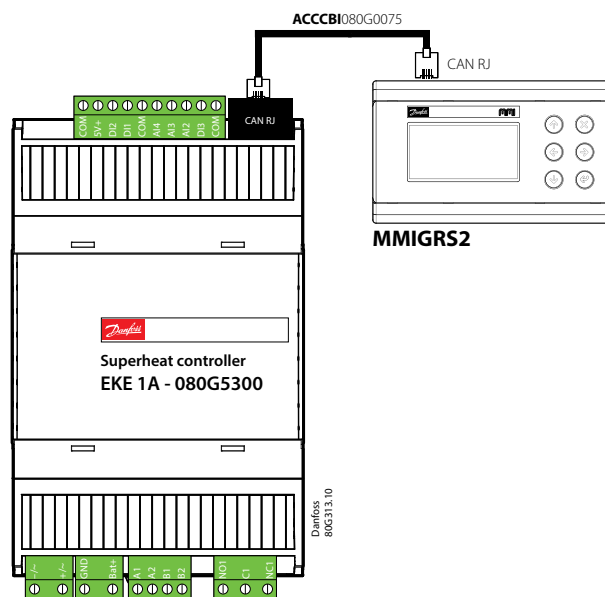

MMIGRS2 (Back view)

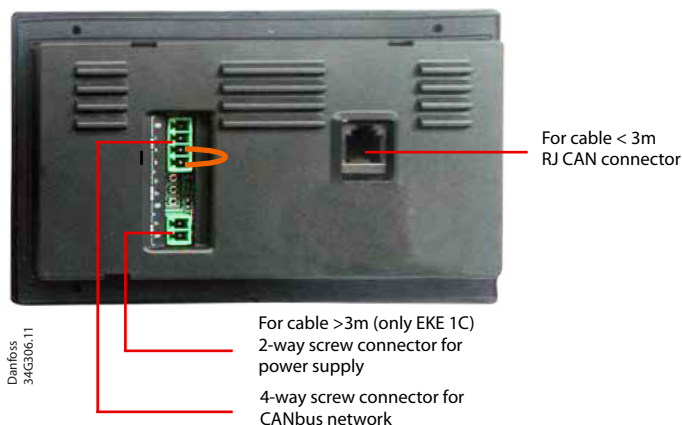

9.2 Main screen

On the main screen the following data are displayed:

- the main analog inputs measurements or other information
- the icon indicating if unit is operating in superheat mode or temperature mode.
- shows the status of the controller
- the alarm or service icon.

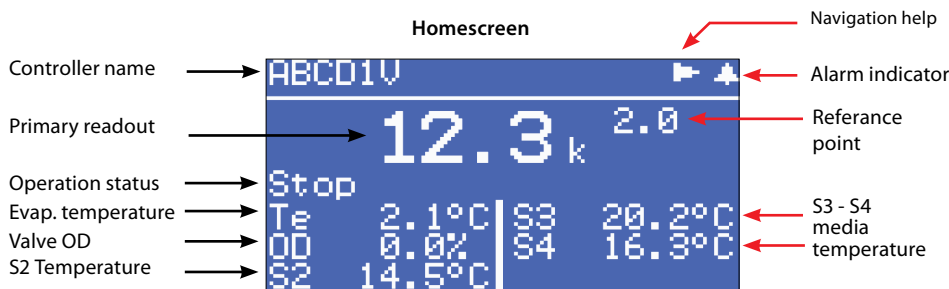

How to change a parameter in MMI display

1. Navigate to the parameter
2. Press enter to get into edit mode
3. Edit value with up/down
4. Accept change with enter

9.3 Display Units and Password

Change of the unit of measurement: Parameter R005

R005 =0 = SI (MET) and R005 =1 = US (IMP)

Metric unit (MET): temperature, temperature offset and pressure units in MMIGRS2 display °C , K and Bar Gauge respectively.

Imperial unit (IMP): temperature, temperature offset and pressure units in MMIGRS2 display °F , R and PSI Gauge respectively.



Note:
Long press Enter key about 3 secs to access Password Screen





Accessing Setup and service menu

The Setup and service menu requires password. 3 access levels are possible to create, where personnel have individual authority.

Most advanced level is **Commissioning**, where you have access to change all allowable parameters, including password issuing and re-run of Setup wizard. Default password for commissioning is 300.

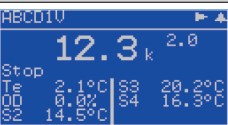
Service level is for service personnel and has fewer rights than commissioning. Default password is 200.

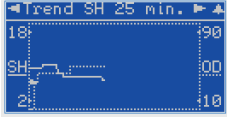
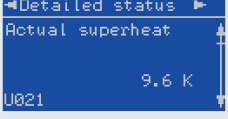
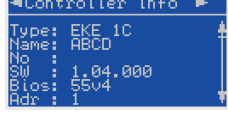
The lowest level is for **Daily** use, and allows only a few changes. Default password is 100.

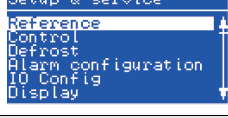
Unit Status	Key	Function	Description
		Home screen	Shows the operating status.
	Right x1	Active Alarm	Access to Active alarm list. Press UP and Down button to see complete list.
	Right x 2	Trend SH 25 min	Shows logged Superheat graph for 25 minutes.
	Right x 3	Detail Status	Shows detail operating status. Press UP and Down to see complete list.
	Right x 4	Controller info	Provides Product info
	Right x 5	QR code	QR code that directs you to the product webpage for more info.
	Enter 3 sec.	Log in / Setup and Service	If User has not logged in, Enter password. Press UP/Down to change digit and Enter to confirm the value.
	Escape/Cancel		Go back to main screen
	Escape 3Sec	Logged out	User log out

Note:
Setup and service menu (requires Log-In Password to be assigned in commissioning menu)

Login	Key	Function	Description
	Up	+	Increment the selected digit
	Down	-	Decrement the selected digit
	Enter	ok	Confirm the value and skip to the next digit or execute login
	Escape/cancel		Go back to main menu.

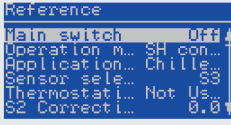
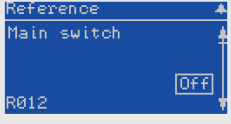
Parameter navigation	Key	Function	Description
Example: 	Up	up	Backward scroll of parameters or group of parameters
	Down	down	Forward scroll of parameters or group of parameters
	Enter		Change to the next group of parameters, if present; otherwise enter in parameter programming mode.
	Escape/cancel	Escape	Go back to the previous menu level, if present or to the main screen
Parameter change Example: 	Enter	Change value OK	Enter in parameter programming mode. Confirm the change
	Up	+	Increment the parameter value
	Down	-	Decrement the parameter value
	Escape/cancel	Escape	Exit from programming mode discard the change

10.0 Wizard set up

Guided configuration for first-time controller setup. Wizard setup is available in both MMIGRS external display and KoolProg software.

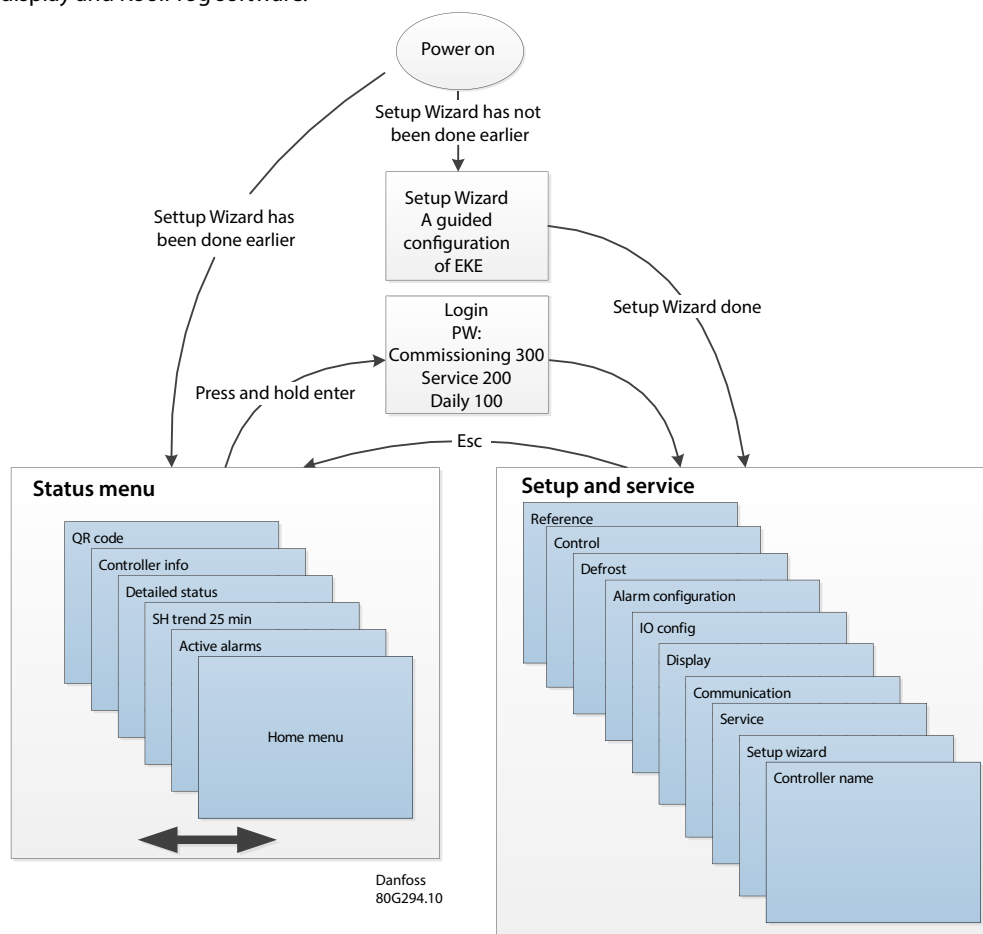

First time start-up (Setup Wizard) via MMIGRS2 display

When all connections to the controller have been made, the first time start-up can be performed. After the power is switched on, the Danfoss logo will appear for 5 seconds. The Setup Wizard will start. Its workflow is: a. Language selection; b. Application selection; c. Input configuration; and d. Output configuration.

When using the Setup Wizard, repeat the following sequence for all parameter settings:

- a. Parameter name + 1st option
- b. Press ENTER to highlight 1st option
- c. Scroll with UP / DOWN to your desired option
- d. If the selected default value is acceptable, press DOWN to get to the next settings. Otherwise, press ENTER to set your choice
- e. Scroll with DOWN to the next parameter (repeat sequence a. to e.)

Note:

- If you do not have sufficient information to complete the Wizard, leave settings on their default values. To generate the requested info, you can use Danfoss Coolselector2 software to calculate operating conditions and valve OD for the same operating point.
- Setup Wizard only covers the most important parameters. If other application dependent features are to be enabled (e.g. Alarm settings, MOP/LOP, etc.), they must be configured separately once the Setup Wizard is done.

Setup Wizard is also available in KoolProg PC tool. The workflow process is the same as that described above for MMIGRS 2 display.

Guided configuration for first-time controller setup. Wizard setup is available in both MMIGRS external display and KoolProg software.

Alarm and error codes:

When detecting an alarm from external sources or the flashing bell in the display, the alarm description can be found as a text message in the Status menu under Active alarms. Both alarms and errors will be shown here. If more alarms/errors occur simultaneously, they will be shown as subsequent text lines.

11.0 User interface
KoolProg



Warning!
For updated EKE software versions it is required to install the latest KoolProg software versions to have the full compatibility

KoolProg

KoolProg is a software tool that can configure the EKE Controllers in fast and easy way. The main feature of the KoolProg are listed as follows.

- Make Online changes to parameter configurations
- Monitor live status of inputs and outputs
- Quickly analyze controller behavior. and program patterns by using the graphical trending tool

KoolProg Software is available for download free of charge at <http://koolprog.danfoss.com>
The customer will first be guided through a registration process before download can commence.



Important note!
To guarantee a reliable USB connection to a host device (e.g. industrial PC), you must: keep USB cable length < 1 m.

Kool Prog software do not support multiple EKE controllers in a daisy chain network.

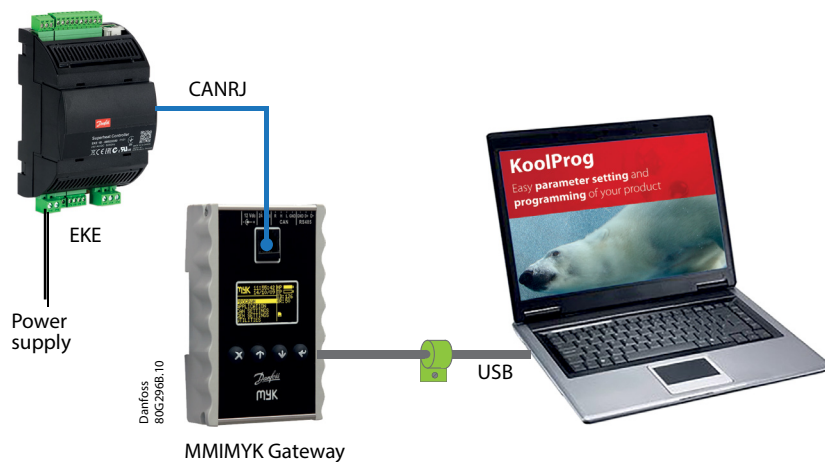

EKE must be powered up before starting programming.





Note:
In offline mode, upload the file to the controller, by pressing Export button.

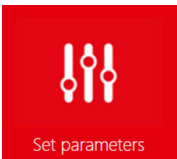
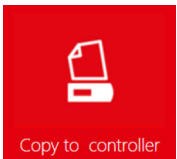

 Set parameters Offline mode	 Copy to controller	 Service and test Online mode
<ul style="list-style-type: none"> • Create your own configuration files on your PC without having to connect a controller. • Import a parameter configuration file to your PC from a connected controller. Save the file and download it to other controllers of the same model. • Select the most frequently used parameters as your favorites. • Find all the technical documentation for each controller model within one location. 	<ul style="list-style-type: none"> • Quickly program one. or multiple controllers by using the progress and completion status indicators 	<ul style="list-style-type: none"> • Quickly analyze controller behavior and program patterns by using the graphical trending tool • Make Online changes to parameter configurations • Monitor live status of inputs and outputs

11.1 Setting up

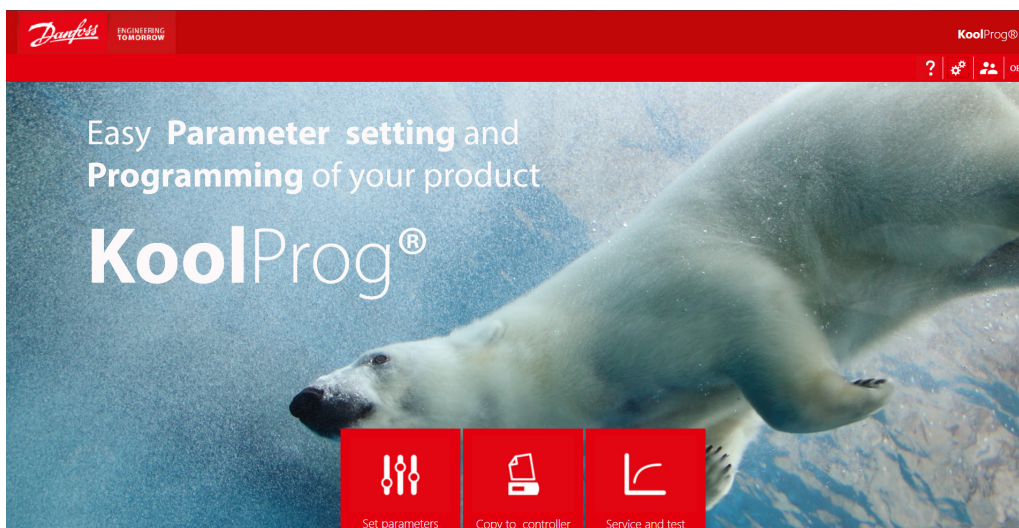

11.2 Main Screen

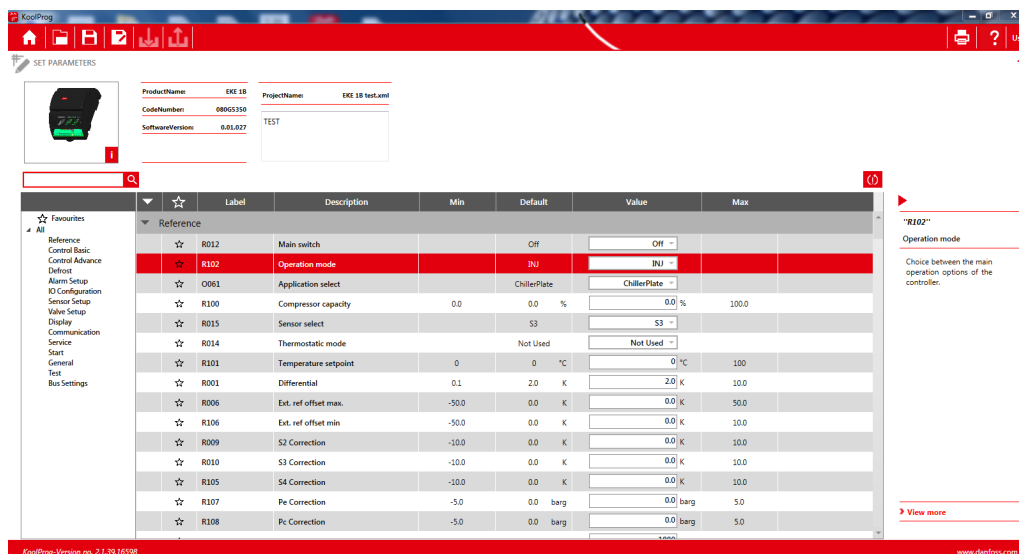

11.3 Service Menu

Note:
Active alarms, Readouts are only available in Online mode i.e service and test

Active Alarms - Points to the Active alarms section showing 'W002 Standby mode'.

Search Parameter - Points to the search bar containing '.....'.

Favorites - Points to the Favorites list on the left.

Parameter Group - Points to the Reference table.

Detail Parameter info - Points to a specific row in the Reference table (R102).

Label	Description	Min	Default
R102	Operation mode		SH control
O061	Application select		
R015	Sensor select		S3
R014	Thermostatic mode		Not Used
R101	Temperature setpoint	0.0	3.0 °C
R001	Differential	0.1	2.0 K
R009	S2 Correction	-10.0	0.0 K
R010	S3 Correction	-10.0	0.0 K
R107	Pe Correction	-5.0	0.0 barg
N100	MTR Tn	-20	1800
N101	MTR Kp	1.0	3.0

Search feature will only display the parameters relevant to your settings. Example I035, i034 min max external voltage reference only appears if you select R102 as 'Valve driver' and I033 as 'Voltage to OD'

11.4 Graph- Datalogger

Note:
Datalogger is only available in Online mode i.e service and test

Log parameter	MenuCode	Color	Min	Max	Value
Actual OP	0004	Blue	0	100 %	24.4 %
Actual superheat	0021	Yellow	1.1 K	27.6 K	1.1 K
Actual S1 reference	0022	Black	7.4 K	7.5 K	7.4 K

Monitoring the operation

When the startup is complete with success you can setup the datalogger. The datalogger work over the service port so use of KooolProg / MMIGRS2 is not possible when datalogging is active. In case of need to check operation, it requires to stop the datalogger and reconnect KooolProg/ MMIGRS2.

12.0 Configuration

Apart from wizard setup, users can also use the following section which describes quick parameter settings for general applications.

12.1 Quick guide for parameter selection

Note:
 I036, I037 Ext ref. current available on EKE 1C only

Note:
 Some important Parameters e.g Superheat close function, Pcontrol, valve neutral zone are enabled in a default settings. Make sure that you activate other feature/function/ alarm as per the application requirement before you start the controller.

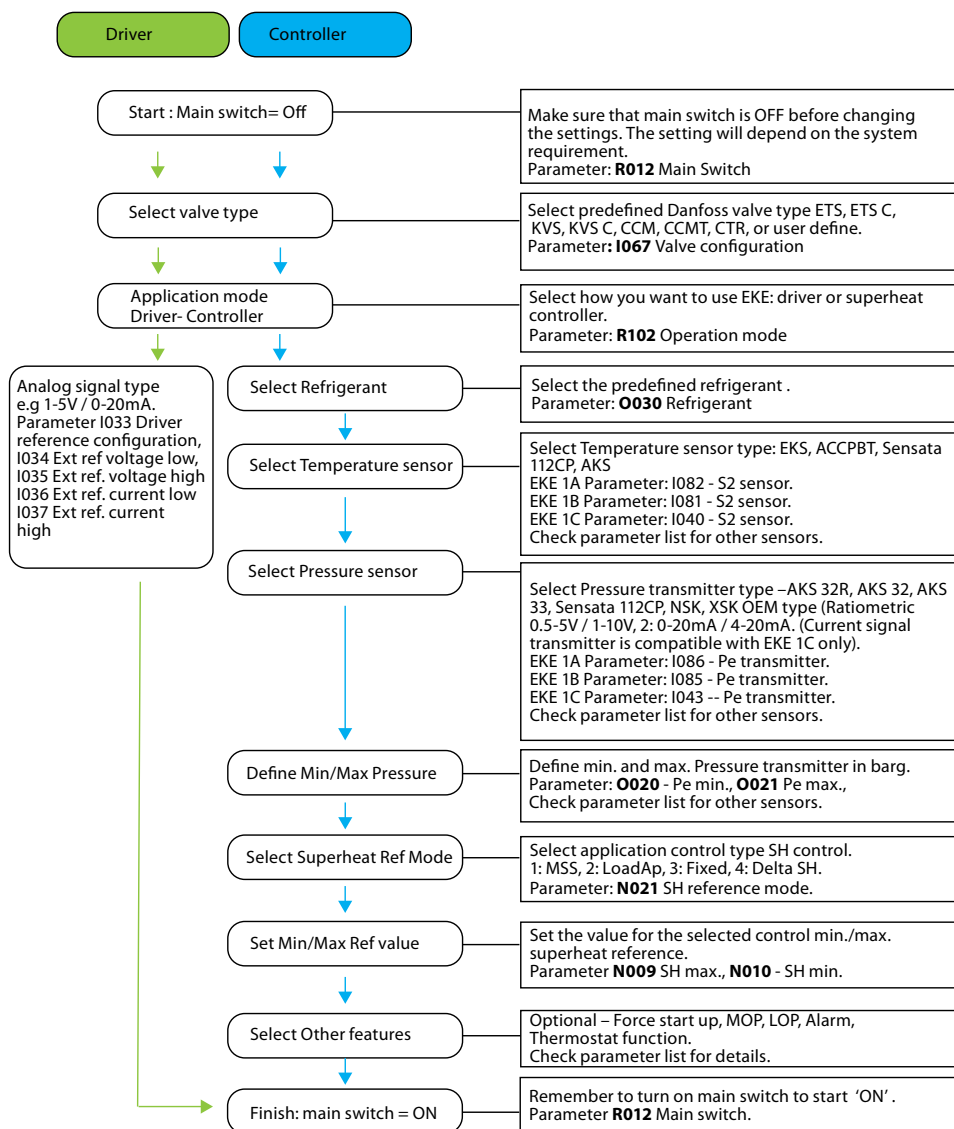

12.2 Before starting controller checklist

When the electric wires have been connected to the controller. the following points have to be attended to before the regulation starts:

Before using EKE controller, there are compulsory settings that have to be made for each individual application.

Interaction between internal and external start/stop functions and active functions

If DI ON/OFF function has been used as a Injection control ON/OFF, then the interaction between internal and external start / stop function is as shown on the following table:

Functions	Features			
R012 - Main switch	OFF	OFF	ON	ON
External Start/stop (DI)	OFF	ON	OFF	ON
	Results			
RConfiguration monitoring (eg. S2 not defined)	available	available	available	available
Application monitoring (eg. Low SH)	not available	available	not available	available
Sensor monitoring (Eg. S2 Error)	available	not available	not available	available
Valve OD%	0%	0%	0%	Auto, 0-100%

Wizard

 **Note:**
Wizard only takes main parameters into consideration. Other required features and functions need to be set separately.

The wizard will guide the user to create a parameter settings for a new application/projects in an easier way. The wizard will ask the user multiple questions on the application and the components intended to be used with EKE. When the user is done with wizard, a new set of best suitable parameters are created according to the options the user has chosen. R012 main switch is always OFF when running the wizard.

Refrigerant type

 **WARNING!**
Wrong selection of refrigerant may cause damage to the compressor.

It is possible to choose from a list of 42 different refrigerants in the controller. If the refrigerant is not found on the list, it is possible to enter the Antoine constants for the unlisted refrigerant using communication bus / MMIGRS2 display/KoolProg software tool. See Appendix for detail.

Valve type

It is important to select the right valve type as listed under Valve definition. The guide line for the valve selection is described in section Stepper motor valve.

Temperature sensor

 **Note:**
EKE also accepts external signal value like Po, S2, S3 and S4 via communication bus. For detail check the section "Using external sensor values"

EKE 1A and EKE 1B only support NTC 10K temperature sensor, whereas EKE 1C supports both NTC as well as PT1000 sensor type. The default Sensor configuration is 'non' in EKE 1C controllers. User must select the right temperature sensor type for all relevant sensor positions from the list. If a temperature sensor has an offset, it must be corrected before use. Such offset correction is stored in EEPROM of EKE controller.

Pressure transmitter

 **Note:**
Pressure transmitter having offset will result in inaccurate control, hence sensors with offset must be corrected using Offset Correction through parameter R107 or R108. Pressure value must be entered in Bar Gauge.

Various Danfoss pressure transmitter can be selected from pre configured list. For transmitter that are not covered by the default list, a complete set of parameter must be defined as specified in parameter list under section Pressure sensor configuration.

Once the pressure transmitter is defined, the range of the pressure transmitter can be set by entering the transmitter's minimum and maximum values for the parameter as shown below in table. It is important to note that the right compatible pressure transmitter must be selected with respect to EKE version and connected to the proper terminals as per the application need. Similar to the temperature sensor, if the pressure transmitter has an offset, then it must be corrected. The software correction is done through the parameters as described in Pressure sensor configuration.

All Pressure Transmitters must be configured with a range. And the Pressure values must be defined in **bar Gauge**.

IO Configuration

		EKE 1 Controller				
		EKE 1A	EKE 1B	EKE 1C	Driver Mode	Parameters
Input Output configuration	DI 1	* Not Used Main Switch	* Not Used Main Switch	* Not Used Main Switch	* Not Used Main Switch	[O002 DI1 configuration]
	DI 2	Not Used Defrost start ** Manual Preset OD Heat / Cool	Not Used Defrost start ** Manual Preset OD Heat / Cool	Not Used Defrost start ** Manual Preset OD Heat / Cool	Manual Preset OD	[O022 DI2 configuration]
	DI 3	Not Used Defrost start **Manual Preset OD Heat / Cool	-	-	-	[O037 DI3 configuration]
	AI 1	-	Not Used S3 S4	Not Used S3 S4	-	[I020 AI1 configuration]
	AI 2	S2	S2	S2	-	
	AI 3	p0	p0	p0	-	
	AI 4	Not Used ExtRef	Not Used ExtRef	Not Used ExtRef	Not Used ExtRef	[I021 AI4 configuration]
	AI 5	-	-	Not Used S3 S4	-	[I022 AI5 configuration]
	DO 1	Alarm Liquid Line - Shut Off	Alarm Liquid Line - Shut Off	Alarm Liquid Line - Shut Off	Alarm Liquid Line - Shut Off	[O013 DO1 configuration]



Note:
When Main Switch is not configured to any input it must set to 'On'.

* When Main Switch is not configured to any input it must set to 'On'.
** Described in the section "Manual Control"

Alarm and error codes:

Before starting the controller it is necessary to clear all active alarms and error. The regulation may not start if there is active alarms and error. When detecting a flashing bell alarm in MMIGRS2 display, or active alarms in Koolprog, it has to be solved. In these tools, alarm description can be found as a text message in the Status menu under Active alarms.

If more alarms / errors occur simultaneously, they will be shown as subsequent text lines.

If settings and sensor mounting is correct you will only see "W002 standby alarm" in the alarm list. which can be clear by setting "Reference", "R012 Main switch" = ON.

The details about the Alarms and Errors can be found on the section 'Alarm table'.

12.3 First Start up

After completing the above specified check list, the controller is now ready for start up operation.

First of all, make sure that S2, S4, Pe/Te and superheat is OK. Actual values can found under home screen in MMIGRS2 display or under menu group "service" in Koolprog.

You can now make the first startup. Start the application and make sure that the main switch R012 is ON together with the compressor starting. If the main switch (DI1) is not used, it must be hardwired.

At startup, if the controller is not having optimal performance, following are some of the general tips to tune the controller

- Observe if the valve opens when compressor is starting (024 Actual OD , U118 Operation status)
- Superheat (021 Actual superheat) is not low (below 3K) for long time (1 min), if so N017 startup OD can be adjusted to a lower value
- Superheat is not too high (higher than 15-20K) for long time 3 min, if so N017 startup OD can be adjusted to a higher value
- After 10 min of operation, the superheat should be close to reference ($\pm 2K$)
- After 20 min of operation valve is not hunting (you can select 021 Actual superheat, 024 Actual OD, U026 Te saturated evaporation temperature and U022 Actual SH reference for logging and see the live graph)

13 EKE Application

EKE 1 serves 3 different main applications

- Driver Mode
- Controller Mode
 - Superheat controller
 - Temperature controller
- Service Mode

13.1 Driver

A master is commanding the valve open degree to the EKE controller. The control signal can be:

- Analog signal e.g. 0 – 10 V or 4 – 20 mA
- Bus communication via RS485 (Modbus RTU)

'Normal closed' valve in front of EEV is optional alternative to a battery backup solution which closes the EEV in case of power fail. The Digital output can also be used as alarm indication to the master controller.

The Master can send a start signal to EKE DI terminals. Otherwise control will start after power up.

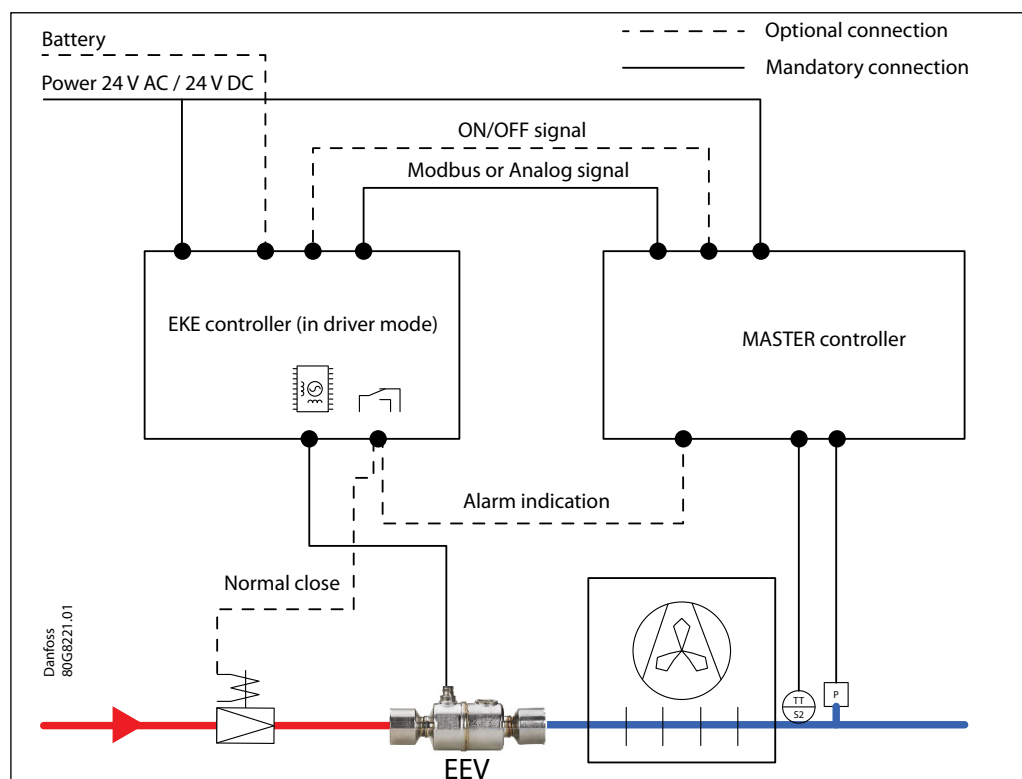

13.2 Controller

EKE is a PI controller for stepper motor valve that controls the superheat of the evaporator based on a pressure P and a temperature (S2) sensors.

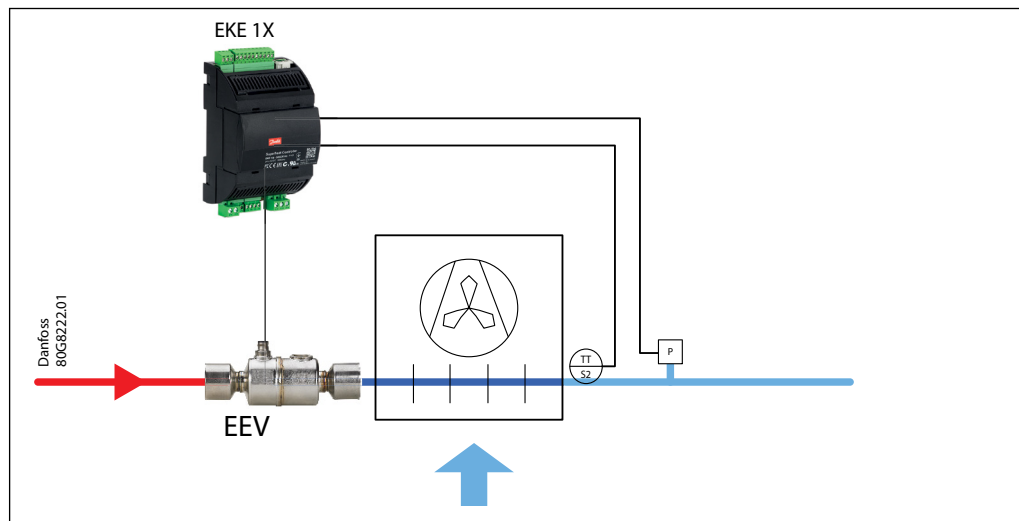

In superheat mode the controller will control the superheat to be stable and close to the superheat reference. This will give the optimal utilization of heat exchanger and there by maximum cooling capacity. If superheat is too low the flow in the expansion is decreased and superheat will be higher. Besides acting as a superheat controller, it can also function as a Temperature controller. this can be accomplished via a signal from temperature sensor S3 placed in the air flow before the evaporator. The temperature control is an ON/OFF thermostat that opens for the liquid flow when refrigeration is required – the stepper valve opens and the thermostat relay cuts in. The detail on the Temperature control can be found on the next chapter.

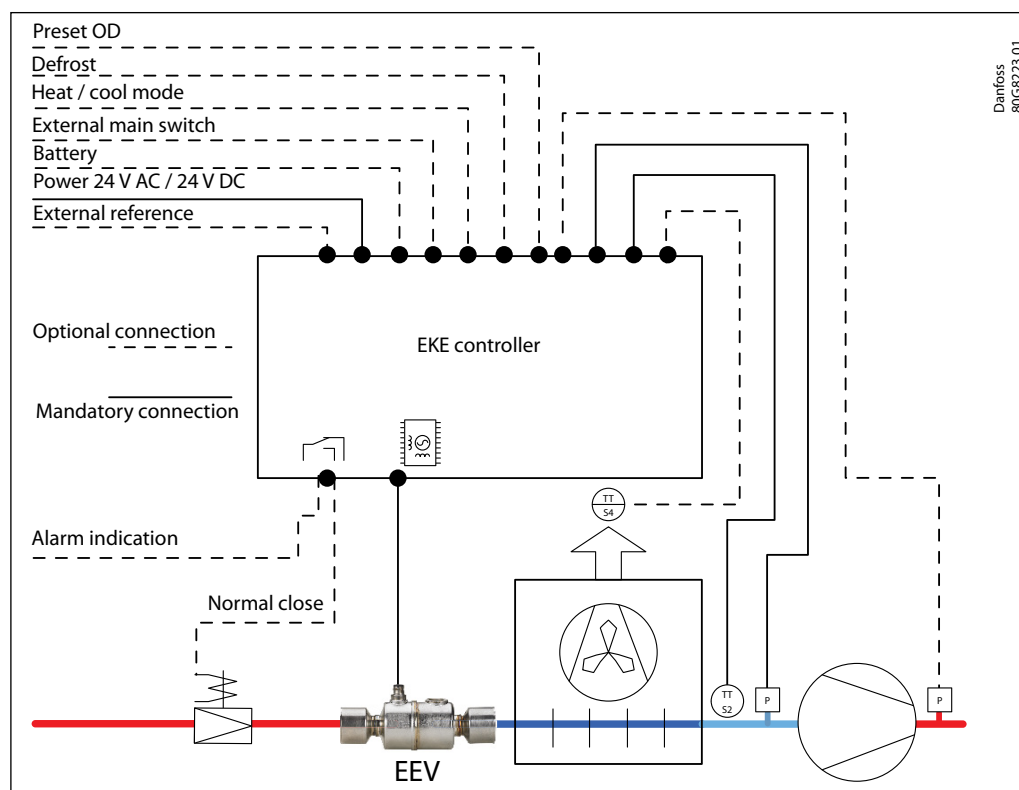

14.0 Driver mode: There are two ways for operating the valve manually which is described in the following sections.

14.1 Using Analog signal

The signal can be used to drive the valve's opening degree to a desired position. This feature is basically used in a service mode to drive the stepper motor valve to the desired level. This can be done even if the EKE controller is not activated by the MAIN SWITCH.

EKE	1A	1B	1C
Applicable	✓	✓	✓
Voltage	✓	✓	✓
Current	-	-	✓

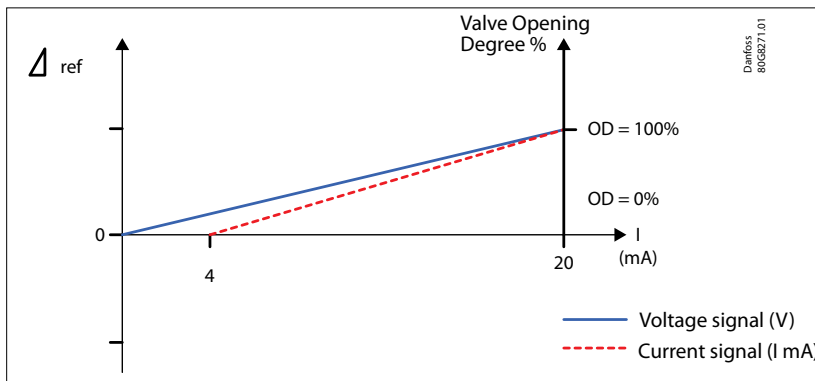

Parameter	Function	Description
RI02	Operation mode	1 = valve Driver, select 1 to operate as valve driver
IO33	Driver reference configuration	0 = Voltage to OD 1 = Current to OD
I037	Ext ref. current high	if IO33=1, define max reference current
I036	Ext ref. current low	if IO33=1, define min reference current
I035	Ext ref. voltage high	if IO33=0, define max reference Voltage
I034	Ext ref voltage low	if IO33=1, define min reference Voltage

14.2 Using Communication bus

The opening degree of a stepper valve can be operated manually between 0% and 100% OD via communication bus.

EKE	1A	1B	1C
Applicable	-	✓	✓

Parameter	Function	Description
RI02	Operation mode	1 = valve Driver, select 1 to operate as valve driver
IO33	Driver reference configuration	2 = Modbus to OD 3 = Modbus to steps
I037	Ext ref. current high	if IO33=1, define max reference current
I036	Ext ref. current low	if IO33=1, define min reference current
I035	Ext ref. voltage high	if IO33=0, define max reference Voltage
I034	Ext ref voltage low	if IO33=1, define min reference Voltage
X004	Modbus main switch	1 = ON, 0 = OFF
X002	Modbus preset OD	1 = ON, 0 = OFF
X010	Bus Ext. ref.	if X002 = 1, define external reference for preset OD

14.3 Switching between Auto and manual mode

The graph explains the switching between automatic and manual mode.

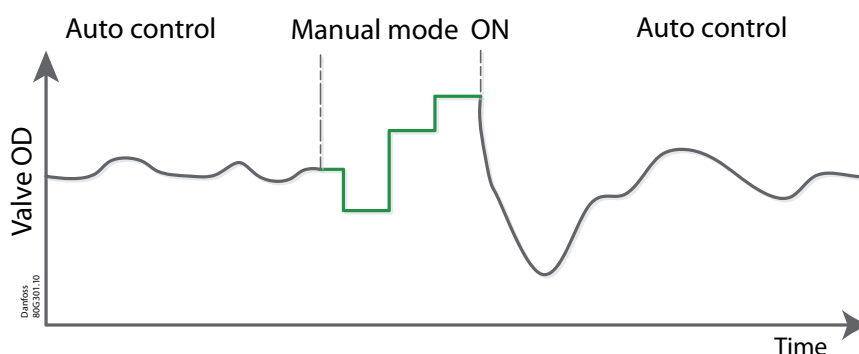

15 Manual Mode

EKE	1A	1B	1C
Applicable	✓	✓	✓

15.1 Manual OD from preset parameter via DI

When DI 2 /DI 3 is configured as Preset OD, the valve OD will be positioned as defined by valve OD parameter [I078 - Preset OD] .

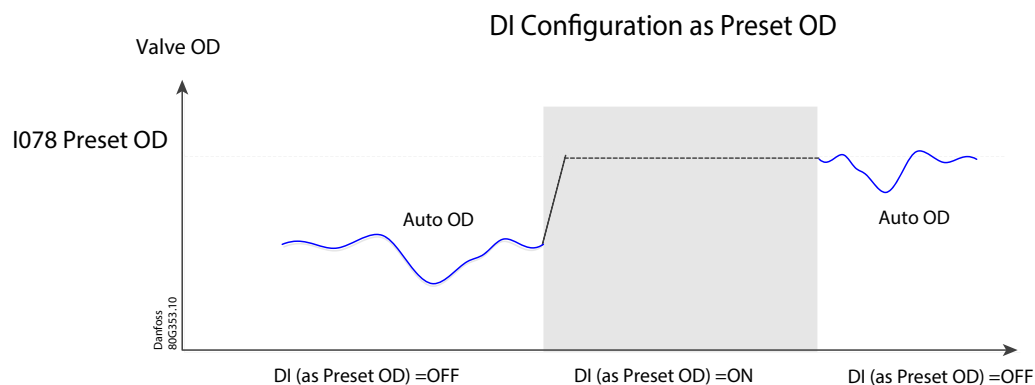

Digital input	O022 DI2 configuration	2 = Preset OD,
	O037 DI3 configuration	2 = Preset OD,
Manual Preset via DI	I078 Preset OD	desired Valve OD %

15.2 Manual control of Relay

Manual alarm control is only possible if manual mode is active. When manual mode becomes active, the state of alarm output will remain the same and be transferred to the parameter(s) for Manual relay DO1. When manual mode becomes inactive the actual state of Manual relay DO1 will be the starting point for the next mode. Activation of manual alarm will not be reflected in the alarm list.

Parameter	Function	Description
O018	Manual mode	1 = On
B101	Manual mode timeout	0 time in sec .When timed out the parameter [O018 - Manual Mode] will be set to Off
B103	Manual relay DO1	0 = Off 1 = ON

15.3 Manual control Valve

When DI 2 /DI 3 is configured as Preset OD, the valve OD will be positioned as defined by valve OD parameter [I078 - Preset OD] .

Parameter	Function	Description
O018	Manual mode	1 = On
B101	Manual mode timeout	0 time in sec .When timed out the parameter [O018 - Manual Mode] will be set to Off
B100	Manual step	Set desired OD in number of steps
O045	Manual OD	Set desired OD in percent

15.4 Manual Homing

Manual homing is done to initialize the stepper motor. This is done to calibrate the valve at Zero OD %. Manual homing is only possible if manual mode is active. When manual mode becomes active manual homing is set to off. When the user set the manual homing to a full closing operation will be performed (same as initial closing). After the operation is performed the manual homing parameter [B104 - Manual Homing] will be set back to off and the parameter for [O045 Manual OD] will be set to 0%. When manual mode becomes inactive the actual OD will be the starting point for automatic control.



Warning:
Too often use of Manual Homing could wear out the valve. For normal operation use overdriving feature

Parameter	Function	Description
O018	Manual mode	1 = On
B104	Manual Homing	0 = Off 1 = On. The value will auto revert back to 0 after setting the parameter

16.0 Temperature control

EKE has 2 methods of controlling temperature:

- ON/OFF thermostat
- Modulating thermostat (MTR)

The need for cooling can either be defined by the incoming media (S3) or the outgoing media (S4).

16.1 ON/OFF thermostat

EKE	1A	1B	1C
Applicable	-	✓	✓

The temperature in the appliance is registered by one or two temperature sensors which are located in the air flow before the evaporator (S3) or after the evaporator (S4) respectively. The actual temperature control can take place in two ways: as an ordinary ON/OFF regulation with a differential or as a modulating control there the temperature variation will not be nearly as great as in ON/OFF control. There is however a limit to the use of a modulating control as it can only be used in central plant. In a decentralized plant the thermostat function with ON/OFF control should be selected. In a central plant the thermostat function may either be selected for ON/OFF control or modulating control.

If temperature is above the set point + differential cooling is started with maximum cooling capacity. In maximum capacity superheat is controlled to be on superheat set point. Cooling is active until the temperature is below set point. Need for defrosting during cooling not considered. If defrosting is needed another system must ensure defrosting is done when needed. In a startup, cooling will active if temperature is above temperature set point.

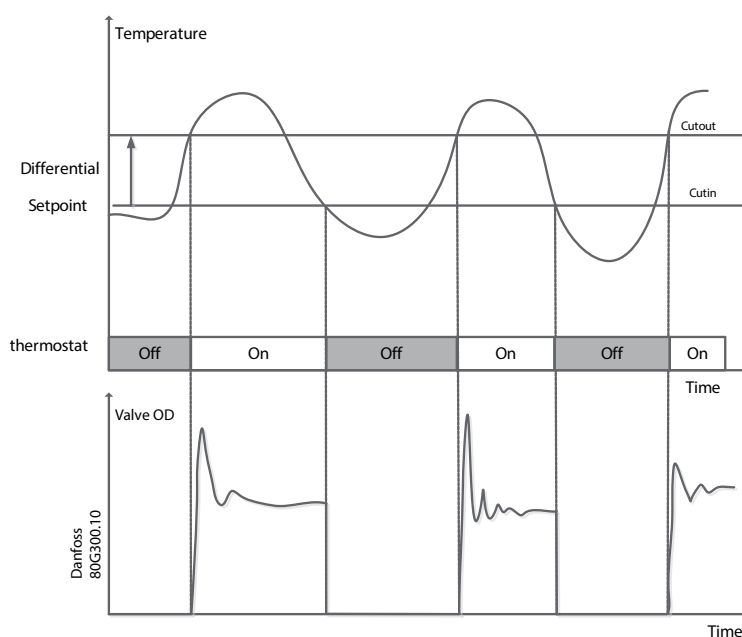
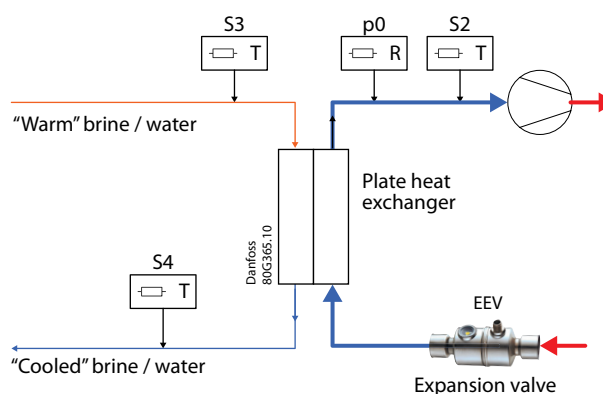

Parameter	Function	Description
R014	Thermostatic mode	1 = Cut in/Cut out
B101	Temperature setpoint, Deg C	define desired media temperature
R001	Differential, K	define cut in point
U118	Operational status	7 = Thermo, cutout, (read value)

16.2 Modulating thermostat (MTR)

EKE	1A	1B	1C
Applicable	-	✓	✓

Modulating temperature regulation maintains a more constant temperature and also equalises the load on the system so that the compressors have better operating conditions:

- This function is typically used on central systems or brine systems.
- Each of the individual evaporator sections is controlled individually using a modulating thermostat function.
- Cut-out value and difference must be set as with an ON/OFF thermostat.

MTR is modulating the cooling capacity to match the cooling demand. In the pull down phase then the temperature is well above the MTR set point cooling capacity is at maximum and superheat is controlled to be on superheat reference. When temperature is getting close to the MTR reference (typical 4 K) the cooling capacity gradually reduce so that the temperature can be stable on the MTR reference. The MTR reference is defined by temperature set point + 1/2 differential.

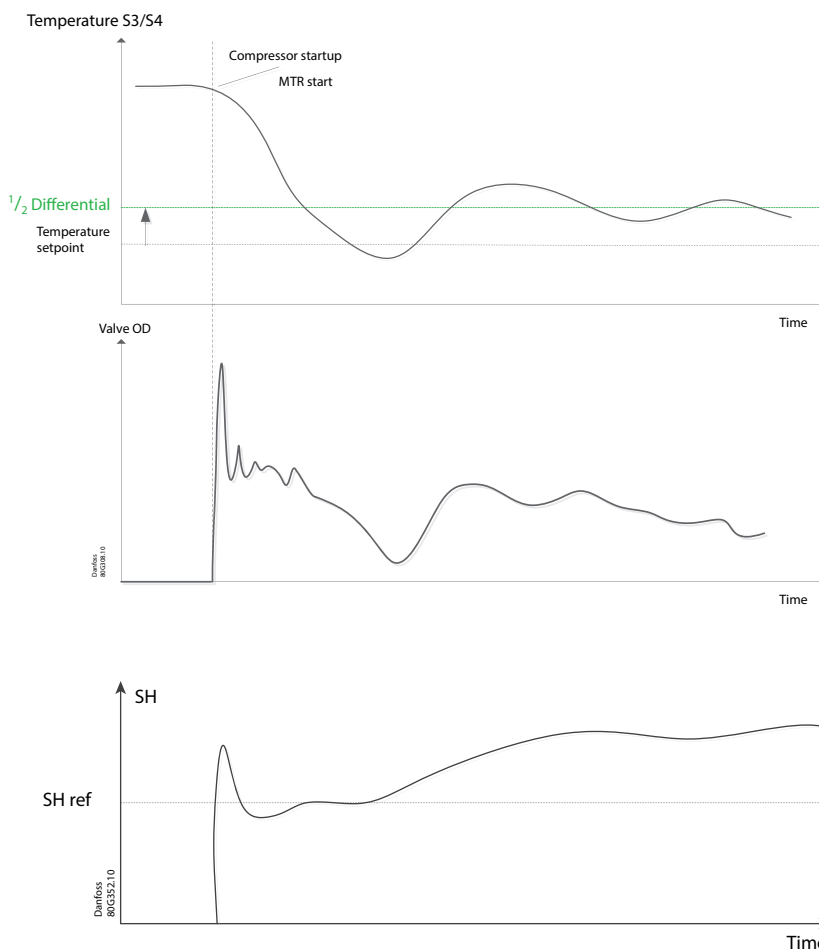

Parameter	Function	Description
R014	Thermostatic mode	2 = MTR
B101	Temperature setpoint, Deg C	define desired media temperature
R001	Differential, K	define cut in point
U118	Operational status	11 = Injection MTR, (read value)

Cut-in/Cut-out vs MTR

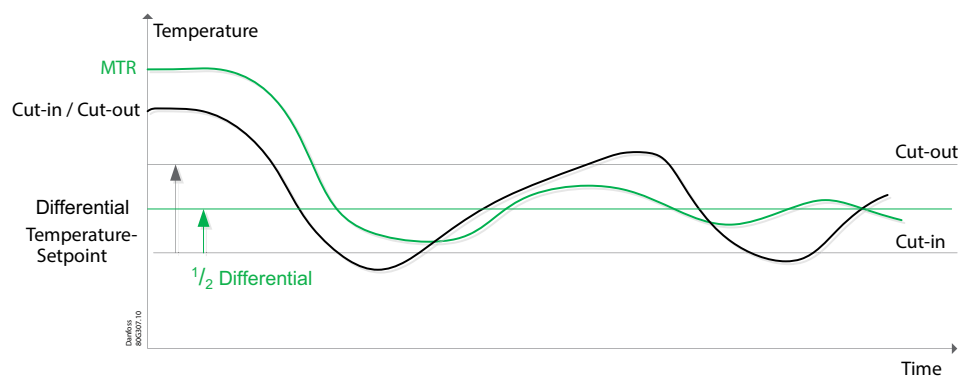

Where to use:

MTR is used in a system where the compressor capacity is regulated to match the load .
MTR will keep continuous operation, Where as ON/OFF thermostat is used in single stage compressor or multi stage compressor where the system is in cut in - cut out mode.

17.0 Superheat reference calculation methods

In superheat mode the controller will control the superheat to be stable and closer to the superheat reference. This will give the optimal utilization of heat exchanger and there by maximum cooling capacity. If superheat is too low, the flow in the expansion is decreased and superheat will be higher.

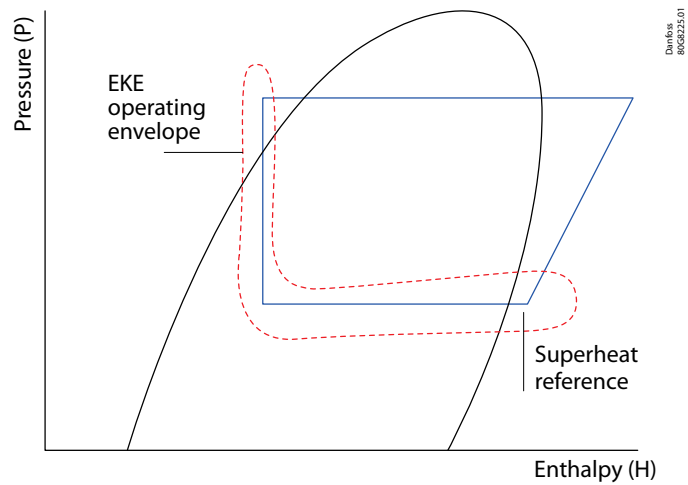

Superheat reference can be calculated based on following different methods:

- Fixed Superheat reference
- Loadap
- MSS
- Delta Temperature Reference

17.1 Comparison between SH reference

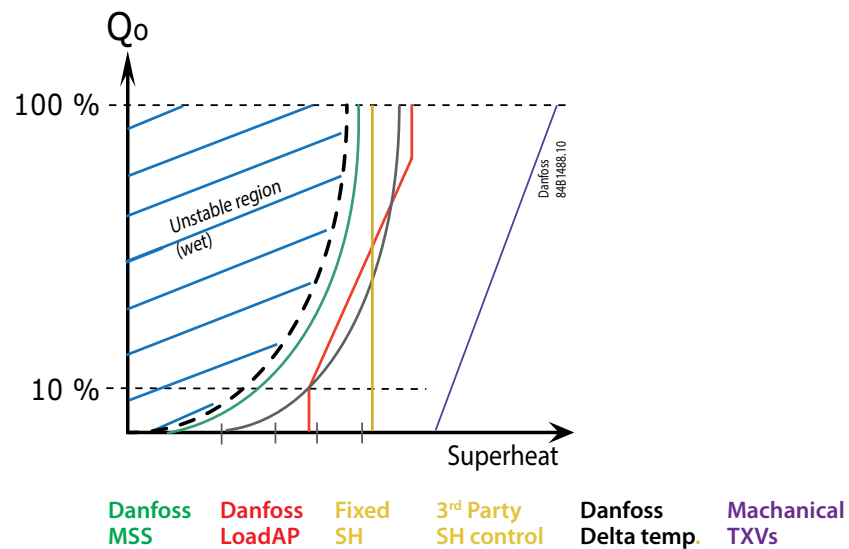

17.2 MSS

EKE	1A	1B	1C
Applicable	✓	✓	✓

The controller will search for the minimum stable superheat between an upper and lower boundry. If the superheat has been stable for a period, the superheat reference is decreased. If the superheat becomes unstable. the reference is raised again. This process continues as long as the superheat is within the bounds set by the user. The purpose of this is to search for the lowest possible superheat that can be obtained while still maintaining a stable system.

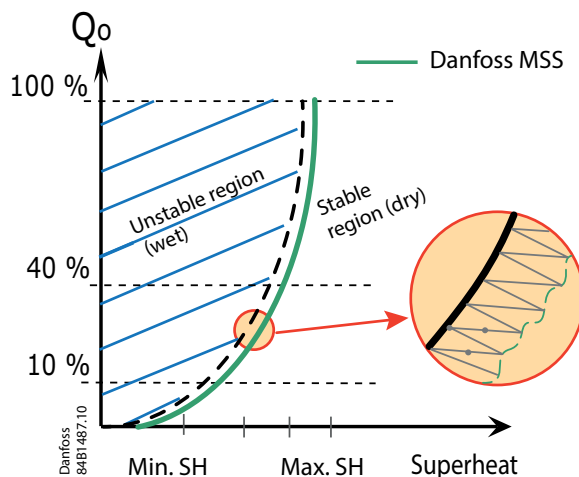
MSS PI controller is made up of 3 parts:

- a stability set point
- the variant from the Te signal
- actual superheat reference

The stability set point is given from the “user”. The variants from the T0 signal is used to allow for increased instability if the T0 signal is unstable. Finally the part from the actual superheat allows for more instability at higher superheat references than at lower references.



Note:
for typical application, as a first step always start the MSS with a start point of 4 K to 8 K and SH close = 2 K.

The superheat reference SH ref is adaptive and adjusted. When using this form of control, there are three settings that have major effect on this mode of control. These are Min. SH, Max. SH and SH close parameters.

Where to use:

MSS is a benefit for system with a long runtime and slow changing conditions like cold rooms, display cases and chillers.

Short cycling and system with fast changing operation condition will not benefit from MSS as this feature will take time to find the optimal reference. Adaption to a new set point is approx. 15min.

Parameter	Function	Description
R102	Operation mode	0 = SH Control
N021	SH reference mode	2 = MSS
N009	SH max. value	Max. allowed SH reference
N010	SH min. value	Min. allowed SH reference Note: SH min. value must be >0.5K higher than SH close value, if N117=1
N018	Stability	Stability factor for regulation of superheat, only relevant for MSS. With a higher value the control function will allow a greater fluctuation of the superheat before the reference is changed.
N129	T0 varians factor	Only relevant for MSS. Te variance factor defines if variation in suction pressure will influence superheat reference. The sh reference change can be adjusted the value 0-1 (1= max Te influence and S2, 0 = S2 only). With often change in suction pressure due compressor start/ stop some Te (and S2)influence on MSS is recommend.
N117	SH close function	0 = Off 1 = On, default = 1
N119	SH close setpoint	default value =2 K (recommended)

17.3 Fixed reference

EKE	1A	1B	1C
Applicable	✓	✓	✓

Fixed reference is normally uses in systems where the load and the operating condition of the unit is stable . This can also be used in systems that periodically on/off the unit in a short run time for example process chiller that maintains the outlet media temperature to a specific set point .

Where to use:

This feature can be used where load conditions and operation is stable or can be use in those ON/OFF units i.e short cycling operation condition

Parameter	Function	Description
R102	Operation mode	0 = SH Control
N021	SH reference mode	0 = Fixed Superheat
N107	SH max. value	This value corresponds to SH max. = SH min. Note: must be >0.5K higher than SH close value, if N117=1
N117	SH min. value	0 = Off 1 = On, default = 1
N119	Stability	default value =2 K (recommended)

17.4 Load AP

EKE	1A	1B	1C
Applicable	✓	✓	✓

LoadAP will adjust reference to be higher if load is higher. Load is indicated by the OD of valve. LoadAP is a kind of preprogrammed MSS curve. This method will give a robust SH reference and can in many case be the best fit for systems.

This form of regulation is similar to the thermostatic valve where the spring force can be adjusted to keep the SH (superheat) in the stable region to the right of the curve.

The advantage over the thermostatic valve is that there are two settings to define the operating curve.

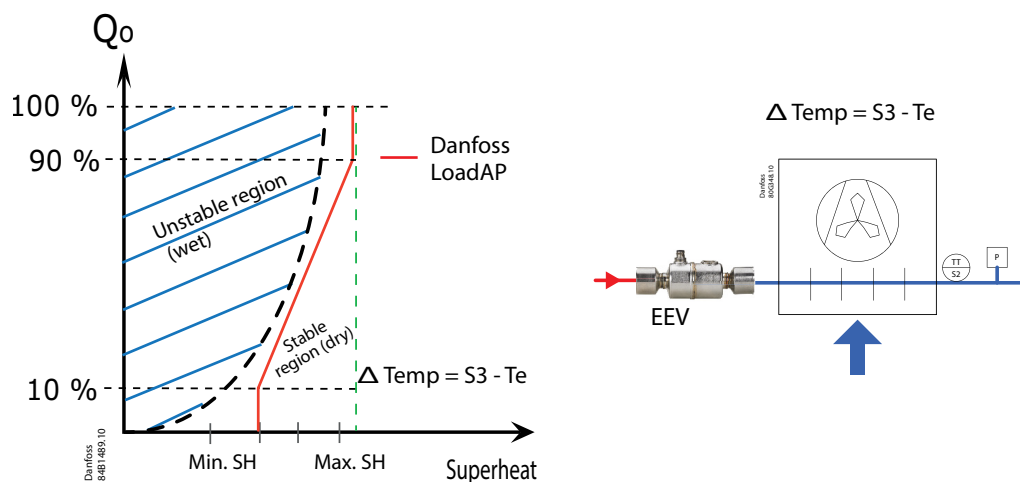

In Load ap application, SH reference follows a defined curve as shown in the diagram. This two point curve is defined by SH max and SH min. These two values must be selected in such a way that the curve is situated between the MSS curve and the curve for average temperature difference ΔT_m (temperature difference between media temperature and evaporating temperature). Setting example: SH close = 4, SH min = 6 and SH max =10 K.

This make the regulation more stable compare to MSS because it does not seek a usability as the adaptive control does.

Where to use

LoadAP feature is advantageous compare to MSS in application having parallel evaporators with common suction line because the loadAP controls the opening based on the actual amount of SH. The MSS mode adjusts based on the SH above or below the setpoint.

Parameter	Function	Description
R102	Operation mode	0 = SH Control
N021	SH reference mode	1 = LoadAp
N009	SH max. value	SH max. defines the reference for OD between 90-100% SH max. must greater than or equal to SH min.
N010	SH min. value	SH min defines the SH reference for OD between 0 and 10%. Note: SH min. value must be >0.5K higher than SH close value ,if N117=1
N117	SH close function	0 = Off 1 = On, default = 1
N119	SH close setpoint	default value =2 K (recommended)

17.5 Delta temperature reference

EKE	1A	1B	1C
Applicable	-	✓	✓

Note:
 It is must to use media temp in S3 sensor to enable this feature.
 It is only available on EKE 1B and 1C.
 Can only be used for air cooled system with Finn and tube evaporator.

With Delta temperature control function, it is possible to regulate the superheat SH with extra information such as evaporator pressure Pe and media temperature S3. Delta temperature is based on the fact that most evaporators has a good efficiency if the SH reference is set to be 0.65 multiplied by temperature difference from inlet temperature to evaporating temperature.

The advantage in using this regulation is that the the controller can regulate in a quicker response to load changes.

The regulation senses the load situation and is much better to respond to changes such as cut in and cut out of capacity steps, condenser fan steps and starting with empty or full evaporators.

SH reference is calculated as a ratio between the media temperature and evaporator temperature. This reference mode is only possible if media temperature (S3) sensor is available.

Evaporator temperature is calculated by knowing pressure and refrigerant.

The behavior is defined by 2 parameters:

- SH reference mode: mode selector between the different SH reference modes
- SH ratio: SH reference = ratio* (S3-T0)

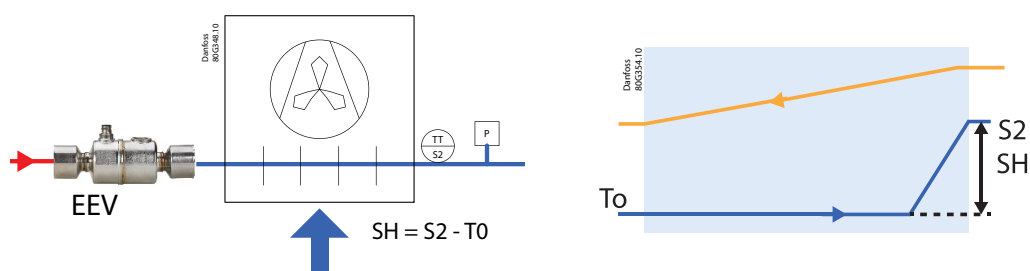
Where to use

Delta temperature is useful when big variations in inlet temperature can be foreseen (ex. Heat pumps running on ambient air). Also variation in suction pressure due stage controlled compressor will be compensated.

Parameter	Function	Description
R102	Operation mode	0 = SH Control
N021	SH reference mode	3 =Delta temp
N009	SH max. value	
N010	SH min. value	Note: Value must be >0.5K higher than SH close value ,if N117=1
N116	SH ref. delta temp factor	Note: this value should be between 0.4 and 0.1. Lower value may flood the compressor where as higher values will result in low efficiency
N117	SH close function	0 = Off 1 = On, default = 1
N119	SH close setpoint	default value =2 K (recommended)

18.0 SH or Temp Reference via External signal

Superheat reference or temperature reference can be offset by external analog signal. SH reference is not allowed to offset the signal below SH min. Parameter (R006 Ext. ref offset max., R106 Ext. ref offset min.) define the range of the offset, parameter (I034, I035) and (I036, I037) define the signal range of the external signal (default is 0-10 V and 4-20mA)

Note:
The curve can be defined in reverse direction as well.

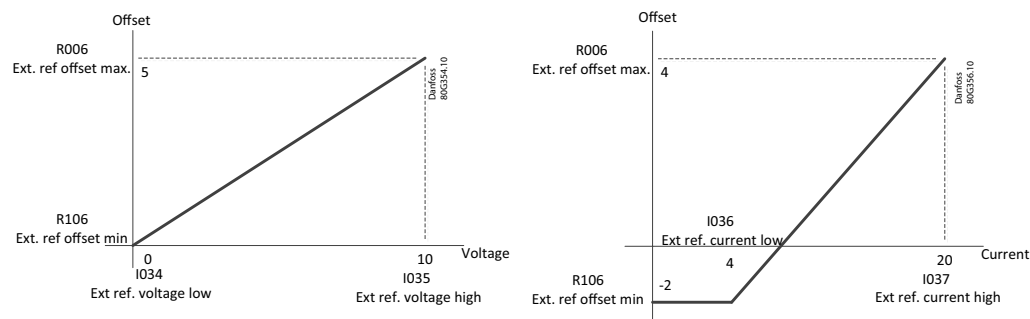

18.1 SH reference

Using the SH Reference via the analog input a displacement can be made of the temperature reference or of the superheat reference. The signal can either be a current signal or voltage signal. The reference can be displaced in positive or negative direction.

EKE	1A	1B	1C
Applicable	✓	✓	✓

Parameter	Function	Description
O010	Ext ref. configuration	define how the external reference signal is used
		3 = mA->SH: External current signal offset superheat reference
		4 = V->SH: External voltage signal offset superheat reference
		5 = Modbus->SH : Modbus give offset to superheat reference

I037	Ext ref. current high	if O010=3, define max. reference current
I036	Ext ref. current low	if O010=3, define min. reference current
I035	Ext ref. voltage high	if O010=4, define max. reference Voltage
I034	Ext ref voltage low	if IO010=4, define min. reference Voltage
X010	Bus ext. ref.	if O010=5, define offset in Kelvin

18.2 Temperature reference

Temperature reference can be change as described above using either 0 – 20 mA signal or 4 – 20 mA signal.

EKE	1A	1B	1C
Applicable	-	✓	✓

The thermostat reference can be displaced via an external voltage signal which is particularly useful for process cooling. The signal may be e.g 0 – 5 V or user defined voltage signal. Two offset values must be set, one indicating the displacement at minimum signal and another indicating the displacement at maximum signal. The displacement will apply to all sections. The displacement will not affect the alarm limits.

Parameter	Function	Description
O010	Ext ref. configuration	define how the external reference signal is used
		1 = mA->Temp: External current signal offset temperature reference
		2 = V->Temp : External voltage signal offset temperature reference
		6 = Modbus->T: Modbus give offset to temperature reference

I037	Ext ref. current high	if O010=3, define max. reference current
I036	Ext ref. current low	if O010=3, define min. reference current
I035	Ext ref. voltage high	if O010=4, define max. reference Voltage
I034	Ext ref voltage low	if IO010=4, define min. reference Voltage
X010	Bus ext. ref.	if O010=5, define offset in Kelvin

18.3 Compressor feed forward SH reference

EKE	1A	1B	1C
Applicable	-	✓	✓

When a compressor speed changes, system dynamics change correspondingly. An adaptive controller is preferred to meet the control performance requirement on both functionality and safety. Feed forward compressor speed implemented in EKE controllers acts as an advantageous functionality to handle such situations.

When a compressor speeds up or slows down, evaporating pressure will change immediately which results in increase or decrease of superheat respectively. Feed forward compressor speed function will auto tune the PI control values to react according to the new change conditions to meet the control performance as well as safety.

To use this feature bus communication is needed and the master controller must send the feed back of the compressor speed to EKE controller.

Note: This function is basically used in one to one systems and requires a modbus to feed the compressor speed. This functionality may not be used in multi-evaporator system.

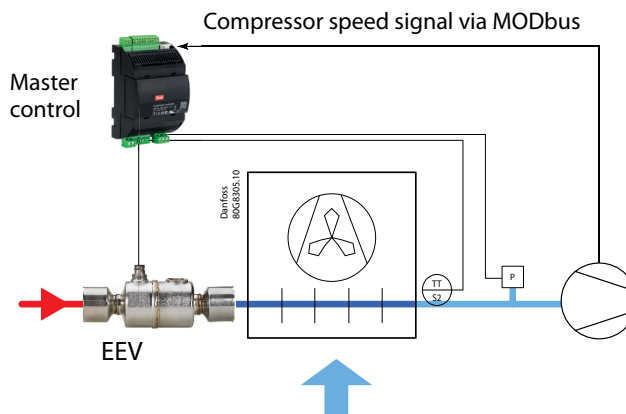

Parameter	Function	Description
N135	Comp. speed feed forward function	0 = Off 1 = On, default Off
R100	Compressor Capacity	compressor capacity value in % via Modbus
N136	Comp. FF low cap. point	The point where sh control is starting to slow. Below this speed superheat control is slower
N137	Compressor FF ShTn factor	The maximum add to the integration time. At 0 % the TN = normal Tn * Comp FF SH Tn factor
G004	Modbus min. update interval	5 sec, default . The system controller must update EKE with updated value within this interval of time

Where to use:

This feature is typically using in VSD system. This can also be use in multi stage compressor. The system controller must send the compressor capacity % value over modbus.

19.0 General Limiter This section explains the various protection features available in EKE controller.

19.1 Priority of limiters With the many number of limiters there could be conflict in which limiter is the dominant one. The priority of the limiters are as follows :

1. Superheat close (it is always important to avoid liquid back to the compressor)
2. LOP (Low operating pressure)
3. HCTP (High condensing temperature protection)
4. Min. S4 (Minimum S4 temperature)
5. MOP (Maximum operating pressure)

As an example can be that the pressure is low and on the same time the superheat is low. LOP control would like to open the valve to raise the pressure. but sh close will decrease the flow to regain a safe superheat. In this case the LOP demand is overruled by SH close. So in the end if the conflict still is active the mechanical low pressure switch will need stop the compressor.

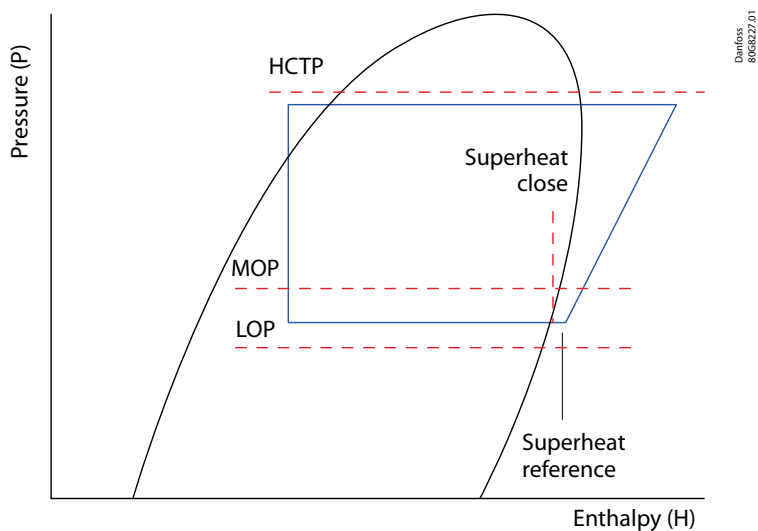

19.2 Superheat close

EKE	1A	1B	1C
Applicable	✓	✓	✓

SH close secures that superheat is kept on or above Shclose set point. This is done in order to avoid liquid getting back to the compressor. If the media inlet temperature drops or if compressor goes down in capacity the superheat may drop below the shclose setpoint. SH close is a fast control function which reduces the flow in the expansion valve to bring superheat up to SH close setpoint.

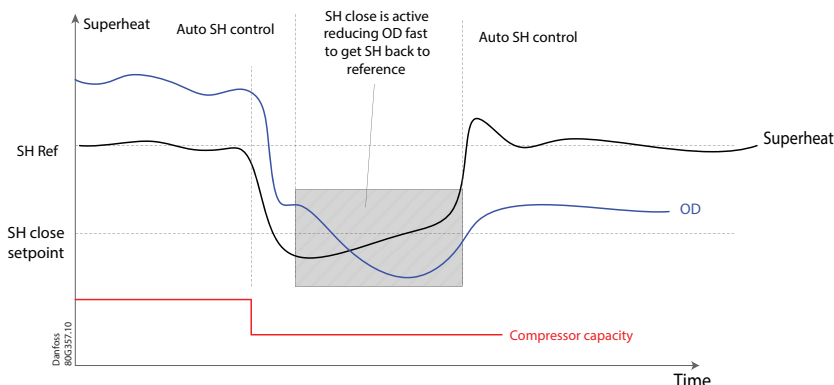

Parameter	Function	Description
N117	SH close function	0 = Off 1 = On, default Valve = On
N119	SH close setpoint	Default value = 2 K

19.3 Lowest Operating Pressure (LOP)

EKE	1A	1B	1C
Applicable	✓	✓	✓

This feature is typically used in application such as Heat pump to operate at lower ambient conditions. Lowest Operating Pressure (LOP) will make sure that the evaporating pressure (Pe) is kept above LOP set point. During startup at low outdoor temperature and when compressor change to higher capacity, it may be needed to keep the suction pressure above LOP set point to avoid stop on low pressure switch. In such conditions, the only way to keep the unit running is by letting LOP override SH control.

This feature will prevent the compressor from stopping due to low suction pressure. If the pressure comes below this limit the controller will quickly open the valve.

Warning:
 As default, controller will not allowed to open the valve when the superheat is low. If such feature is needed for a short time, parameter "N142 LOP priority mode" can be set to ON. This will allow LOP to have higher priority than bringing the superheat out of low superheat for the time defined in "N131 LOP max. time". Care should be taken that compressor can handle this condition.

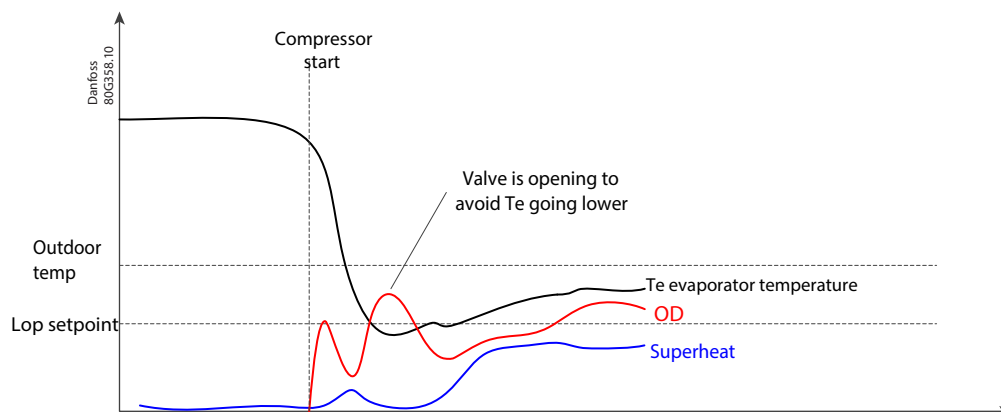

Parameter	Function	Description
N140	LOP function	0 = Off 1 = On, default Valve = Off
N141	LOP setpoint °C	Lowest Operating Pressure setpoint. Setpoint unit is saturated temperature in evaporator -40 °C, default
N142	LOP priority mode	In case of conflict between low pressure and SH close, LOP function can be set to override SH close actions. (Could be needed for startup in low ambient temperatures) On: LOP can override low superheat 0 = Off 1 = On, default = Off
N131	LOP max. time	Maximum time for LOP to override SH close 120 sec., default

19.4 High condensing temperature protection

EKE	1A	1B	1C
Applicable	-	-	✓

High condensing temperature protection will make sure that the load on the condenser is reduced in case the high condensing temperature is reached. This protection prevents discharge pressure from exceeding a set maximum pressure by reducing injection valve OD. HCTP reduces the valve opening degree in such a way that the condensation pressure is kept below a specified setpoint. This can limit the compressor discharge temperature increase caused by changing conditions. The parameter "HCTP temp setpoint" (Max. Pc SetPoint) is determining the HCTP temperature setpoint (converted from pressure input).

Note:
 HCTP feature requires mounting pressure transducer Pc at compressor discharge line or getting its value via Bus

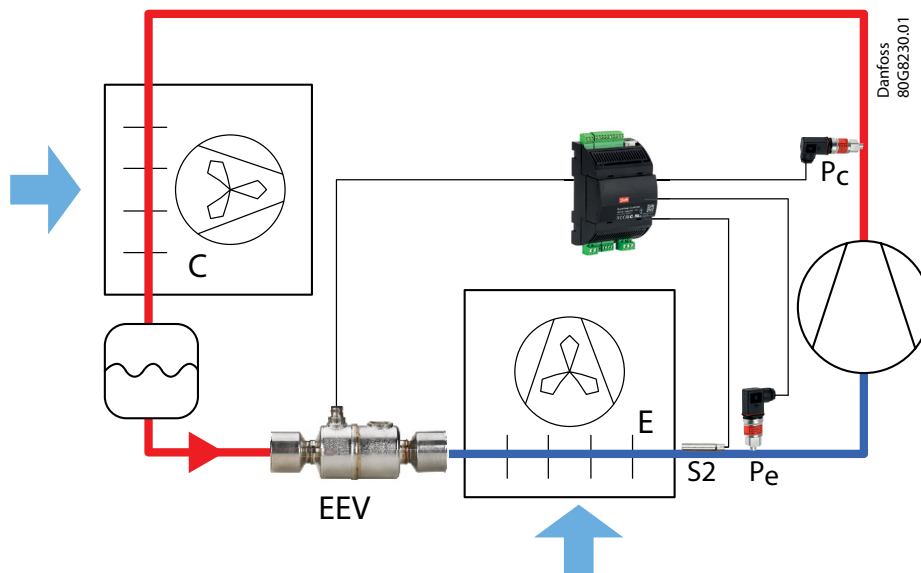

HCTP feature will activate when condensing temperature is inside the HCTP setpoint band. If the pressure stops increasing, the system will operate with HCTP active until conditions allow injection control again. If conditions turn to the worse, pressure will increase and cross the setpoint and an alarm function will monitor as long as this continues. If HCTP is over setpoint longer than the time specified by parameter 'AlarmTimeout HCTP' an alarm is set (parameter A15. Max. time high discharge protection).

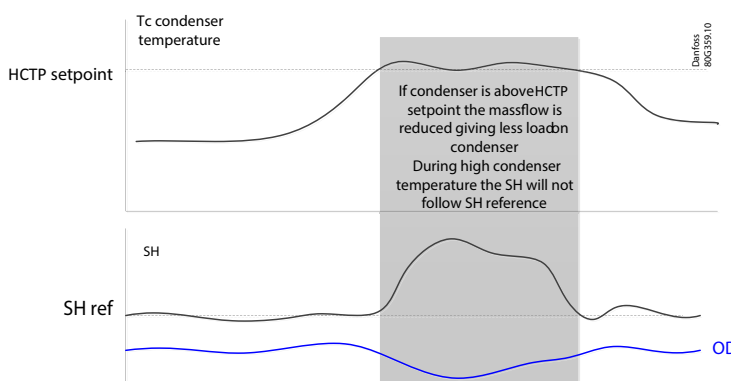

Parameter	Function	Description
N133	High cond. temp. protection function	0 = Off 1 = ON
N134	High cond. temp. protection setpoint	High condensing temperature protection setpoint Setpoint unit is saturated temperature in condenser. 50 °C, default

19.5 Min. S4 / leaving media

This feature is also known as freeze protection. Minimum S4 limit will make sure that the temperature of leaving media out of the evaporator is kept on or above of min S4 limit. An undershoot below the Min S4 is possible, so a frost protection is still needed to secure that the compressor is stopped before the braze plate heater is destroyed by ice.

When min S4 is active the capacity on heat exchanger is reduced by having a lower flow in expansion valve. When min. S4 is active the superheat is higher and superheat will first be back on superheat reference when S4 is well above S4 min setpoint.

EKE	1A	1B	1C
Applicable	-	-	✓

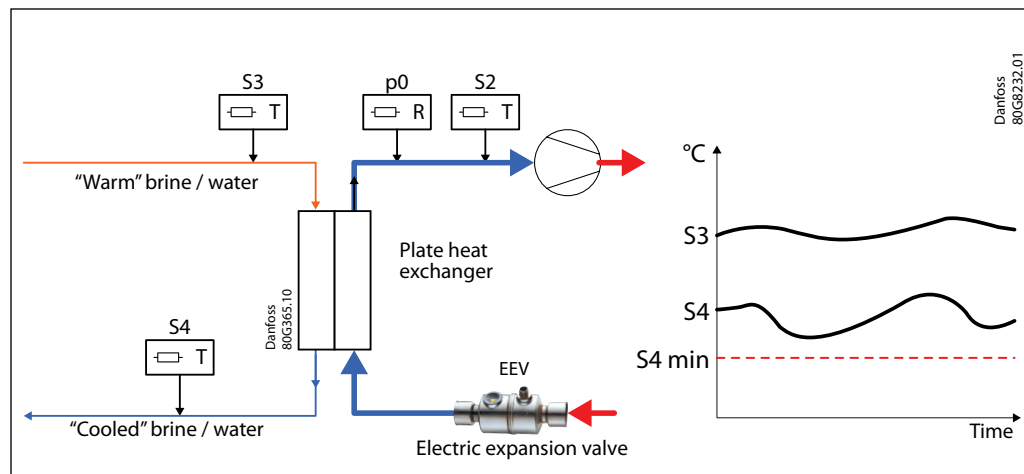

Parameter	Function	Description
N126	Min. S4 mode	Minimum S4 (media outlet) protection function. If S4 get below setpoint the valve will close to reduce capacity 0= Off , 1 = On: Function is active
N127	Min. S4 setpoint	Minimum S4 (media outlet) protection setpoint 5 °C, default

19.6 Maximum Operating Pressure (MOP)

EKE	1A	1B	1C
Applicable	✓	✓	✓

Maximum Operating Pressure (MOP) will make sure that the evaporating pressure (P0) is kept below the MOP setpoint. During startup and pulldown it might be needed to keep the suction pressure low to avoid overload of the compressor. If MOP is active P0 is kept on the MOP setpoint. An overshoot is possible. The MOP setpoint is kept by reducing the flow in the expansion valve. While MOP is active the superheat is higher than superheat reference. This function takes precedence over the superheat control, so during MOP control the superheat is not controlled.

The MOP function is active when N130 parameter is set to ON.

The pressure value is converted to the corresponding temperature value and when the MOP is active, the controller will prevent the evaporating temperature T_e from exceeding this value.

For applications with a need to de-humidify the evaporator, it is possible to control on the saturated evaporator temperature with a MOP function by setting MOP setpoint lower in order to achieve dehumidification of the air.

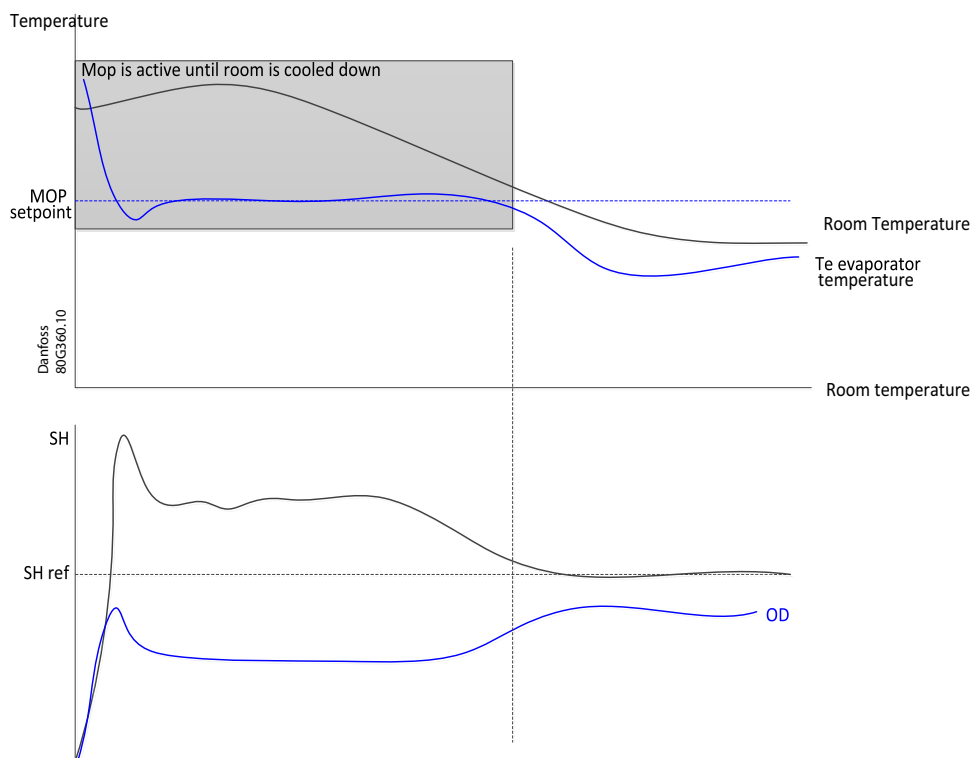
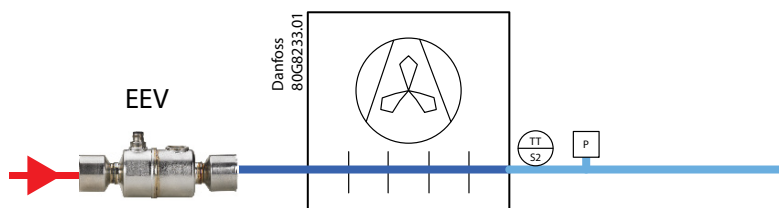

Parameter	Function	Description
N130	MOP function	0 = Off 1 = On, default value = Off
N011	MOP setpoint	Setpoint unit is saturated temperature in evaporator. If the suction pressure reaches the set MOP limit, the valve will close faster irrespective of superheat. 0 deg C, default

20.0 Start up

EKE	1A	1B	1C
Applicable	✓	✓	✓

Sometimes in one to one applications, the valve does not open sufficiently on start-up and troublesome low pressure trips happen. The following features allows the valve to open faster as well as to reach the optimal operating conditions quickly.

20.1 P - Control

P-control function quickly stabilize the system's superheat by reaching optimal operating conditions in shorter period of time. The controller is programmed for auto proportional control that will quickly change the opening degree based on evaporating temperature and superheat of the system.

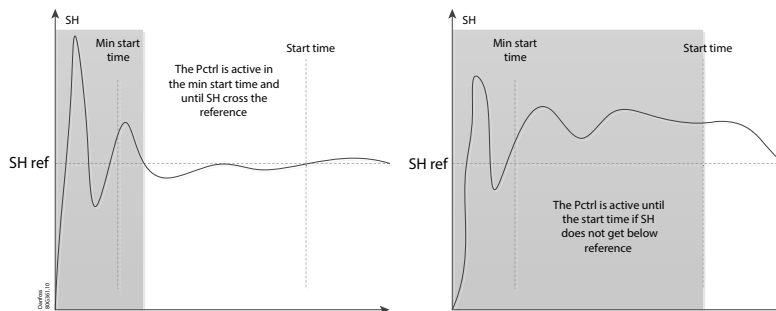

20.2 Start OD with protection

After startup, this function will provide a start opening degree during a set time period. If the limitors such as LOP has been activated, the valve will do the auto adjustment based on the operating conditions and the set limitations.



Note:

At start up, if the valve is opened too big, it could result flow of liquid in the compressor or could trigger the HP switch which will stopped the system. Whereas if you start the system with too low opening degree, it could also stopped the system because of the low pressure switch cut in. It will be safe to start the system with approximately 50% OD of the valve at start up, if P-control is not being used.

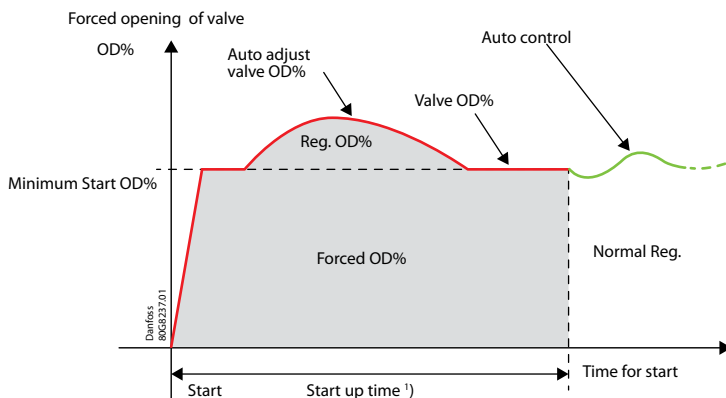

20.3 Fixed OD and time



Note:

No low superheat protection during Fixed OD startup time period.

After startup, this function will provide a constant opening degree during a set time period regardless of the superheat value. No limiters are taken in consideration during this time.

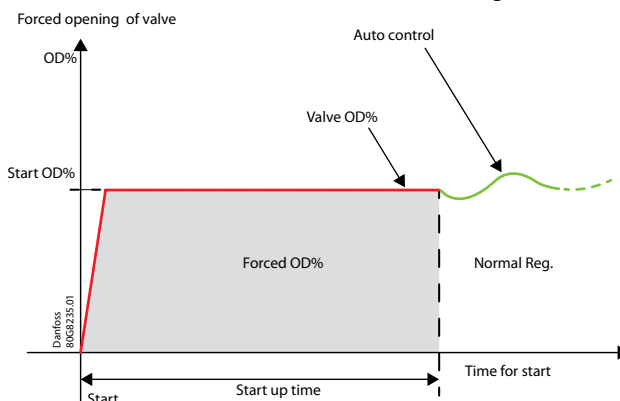

Parameter	Function	Value
N102	Startup mode	0 = Prop. Ctrl 1 = Minimum OD with protection 2 = Fixed OD without protection

Start up mode	P control	Start OD with protection	Fixed OD without protection
Startup OD	N017	N017	N017
Startup time (seconds)	N015	N015	N015
Min. startup time (seconds)	N104	-	-

21.0 Defrost Sequence

EKE	1A	1B	1C
Applicable	✓	✓	✓

Defrost Sequence

Defrost Sequence is not initiated by the EKE, but must be initiated by the master controller. In a standalone configuration, the defrost mode is not possible. It is however possible to enter a special defrost sequence which will overrule the normal control of the valve. To initiate defrost, the system mode is changed from Heat pump to A/C, hereby the outdoor unit will act as a condenser and the hot discharge gas from the compressor will defrost the coil. In some system electrical heaters are used instead of reversible system, but defrost sequence can still be used.

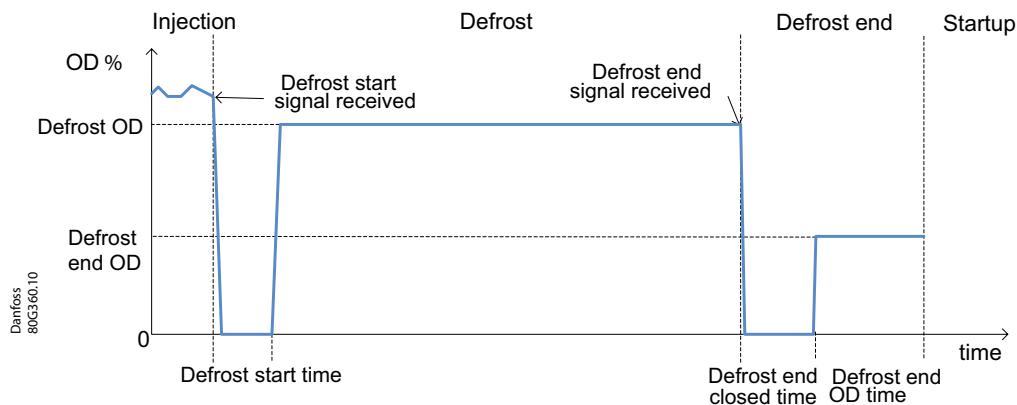

Parameter	Function	Default Value
D101	Defrost start low pressure limit	1 bar g
D102	Defrost start time	1 sec
D100	Defrost OD	0 %
D104	Defrost end closed time	0 sec
D103	Defrost end OD time	0 sec
D105	Defrost end OD	50 %

Defrost sequence start/stop signals can be one of the following options.

1. Modbus register (nonvolatile memory) – default OFF at power-up
2. DI's for use as defrost start/stop. Only one DI can be assigned for defrost start/stop. Start is defined as a transition from off to on, a transition from on to off is a stop signal.

Note: If a DI is setup to control defrost, it's not possible to control defrost via Modbus.

22.0 Reversible systems, dual setting of control parameters

EKE	1A	1B	1C
Applicable	✓	✓	✓

EKE superheat controller is designed to be capable of controlling superheat for a reversible system with bi-flow injection valve (cooling / heating mode). System dynamics in these two operation modes are normally different, hence the EKE controller has been designed to handle dual setting feature i.e to set parameters individually for cooling and heating.

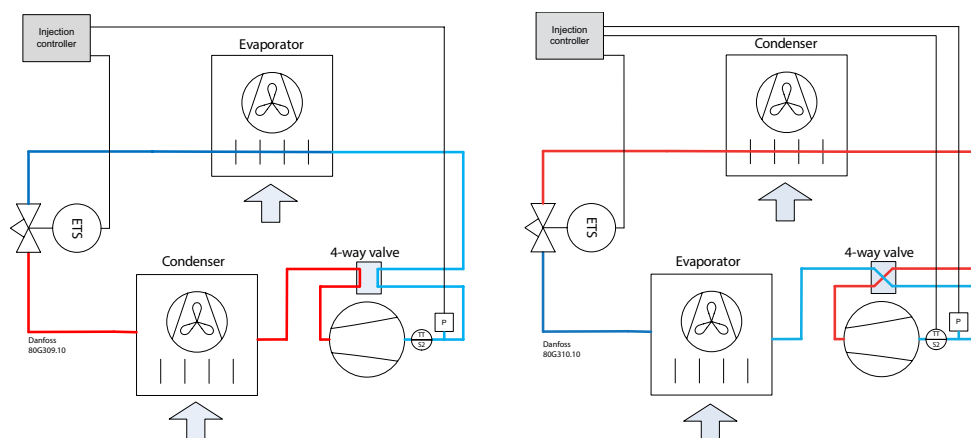
Heat / Cool changeover:

The Heating / Cooling mode can be set via both a parameter and via a digital input. If DI switch has been used, then its parameter cannot be configured to select heating / cooling mode via bus communication.

Parameter	Function	Description
R102	Operation mode	0 = SH Control
N021	SH reference mode	0= Fixed SH, 1=LoadAp, 2 = Mss, 3 =Delta temp

Parameter	Function	Description
X001	MODbus Heating	Heating activated via MODbus
U112	DI Heating	Read the status of DI heating signal

Parameter cooling/function	Parameter heating/function	Description
[N009 - SH max.]	[N108 - Heat SH max.]	Maximum superheat reference
[N010 - SH min.]	[N109 - Heat SH min.]	Minimum superheat reference
[N019 - SH Kp min.]	[N111 - Heat SH Kp min.]	Damping of amplification near reference value This setting damps the normal amplification Kp, but only just around the reference value. A setting of 0.5 will reduce the Kp value by half.
[N004 - SH Kp]	[N113 - Heat SH Kp]	Superheat controller proportional gain If the Kp value is reduced the regulation becomes slower. Increasing the Kp value will make faster regulation. Too high value will create superheat fluctuation
[N005 - SH Tn]	[N110 - Heat SH Tn]	Superheat controller integration time, If the Tn value is increased the regulation becomes slower. Lowering the value will create a faster superheat control. Too low value will create superheat fluctuation.
[N020 - SH Kp Te]	[N114 - Heat SH Kp Te]	Suction pressure (temperature) feed back gain
[N125 - Limit Tn]	[N124 - Heat limit Tn]	MOP/LOP/minS4 controller integration time
[N123 - Limit Kp]	[N122 - Heat limit Kp]	MOP/LOP/minS4 controller proportional gain
[N017 - startup OD]	[N105 - Heat startup OD]	OD at startup
[N107 - SH fixed setpoint]	[N106 - Heat SH fixed setpoint]	Fixed superheat setpoint Warning! Due to the risk of liquid flow the setting should not be lower than approx. 2-4 K. It is recommended to keep this value 2k above the SH closed value.
[N116 - SH ref. delta temp. factor]	[N115 - Heat SH ref. delta temp. factor]	Only relevant for SH reference mode = Delta temp Superheat reference is set as ratio of the average difference from S3 to Te SH reference calculated as (S3-Te) SH ref. delta temp factor.
[N015 - Startup time]	[N112 - Heat startup time]	Maximum time where the injection can be in start mode
[N119 - SH close setpoint]	[N118 - Heat SH close setpoint]	SH close setpoint for fast closing of the valve below this value
[N104 - min. startup time]	[N103 - Heat min. startup time]	Maximum time where the enjection can be in start mode

23.0 Fail safe operation

In the case of sensor error, the EEV controller will go into an emergency mode (“safe mode”), where the valve opening degree is defined by desired OD scheme as described below.

User can read the failure status via [U118 Operation status]

SH control Failsafe mode

Configuration	Description
SH control signal fails. SH control need Pe and S2 signal, so if one of these signal fails, SH control based on the actual superheat is not possible	User can via parameter [N143 SH control sensor error action] control failsafe mode] configure the relevant option. <ul style="list-style-type: none"> o Stop: valve forced closed and SH control (default) o Fixed OD: valve at fixed position (Fail safe OD), this keeps the refrigeration unit running o Use average OD: <ul style="list-style-type: none"> • (calculated as an average of the last hour) to set a reduced OD which will be fixed during error period. This keeps the refrigeration unit running.

Parameter	Function	Description
N143	SH control sensor error	0 = Stop 1 = Fixed OD 2 = Average OD
N145	Fixed OD during emergency cooling	if N143= 1, then define in OD %,

Thermostat Failsafe mode

Configuration	Description
Thermostat sensor error. Thermostat operation needs the signal selected in [R015 Sensor select] to operate the thermostat function, if this signal fails operation based on actual temperature is not possible	User can via parameter [N144 Thermostat sensor error action] configure the relevant option. <ul style="list-style-type: none"> o Stop: valve forced closed, Sh control and Temperature control (default) o Fixed OD: valve at fixed position (Fail safe OD). This Keeps the refrigeration running o “Use Average”= Cutin/cutout use average on and off time to continue cooling. For MTR use reduced OD based average OD <ul style="list-style-type: none"> • MTR: valve at 70% of average OD

Parameter	Function	Description
N144	Thermostat sensor error action	0 = Stop 1 = Fixed OD 2 = Average OD
N145	N145 Fixed OD during emergency cooling	if N144= 1, then define in OD %,

Note:

[N138 Average OD] is calculated during superheat control/ Temperature control is active and stored in EEPROM. Its value is updated every 3 hours. Reset to factory will not delete the calculated average values.

Configuration	Description
Thermostat sensor and SH control sensor error, combination of the 2 above	User has no option to change the value. Stop: valve forced closed (default)

24.0 Service Mode

Service mode is designed to provide a very simple way of operating the valve for diagnostic and service purpose. There is neither application nor protection in this mode. The user can open and close the valve using simple button presses on MMIGRS2.

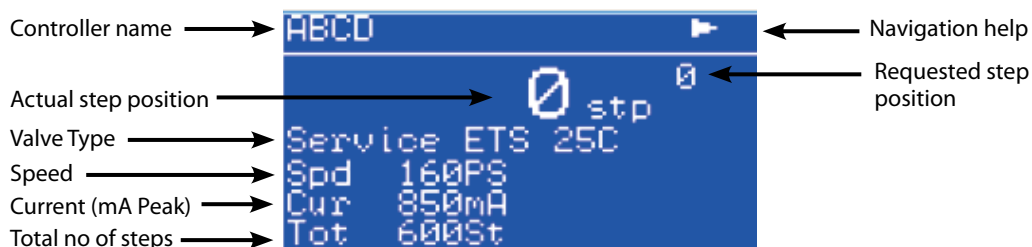

Note: Service mode is only available via MMIGRS2 display. This function is not possible in KoolProg

Service screen

This mode only have a home screen and do not have any menu structure. All function is carried out using the "Escape", "Up", "Down" and "Enter" buttons on MMIGRS2.

Enter Service State

To enter Service State from the normal running application the user must first set the parameter [B105 – Enter Service State] to '1' from the menu system. After confirming this via a popup menu the controller reboots into the Service State.

Valve Selection

In Service State the user must select a valve if this has not already been done. The "No Valve selected" alarm will be activated in the Service State if valve has not been defined.

The "Enter" button brings out the parameter [I067 - Valve setup]. The user can now scroll through the available valves via the "Up" and "Down" buttons to select the desired valve through the "Enter" button. If "User defined valve" is selected the parameters related to the valve configuration will be allowed to set the valve parameters.

Valve Operation

From the status screen it is possible to drive the valve towards open by pressing the 'UP' button and towards close by pressing the 'Down' button on MMIGRS2 display. The valve will operate as long as the button is pressed and stop when the button is released.

25.0 Alarms

25.1 Actions following an alarm

When an alarm occurs, the following actions generally ensue:

- the "Alarm" or "Warning" relay is activated
- an icon and the alarm code is displayed on the screen
 - On units with an LCD display, the list of active alarms appears with the relative description

The alarms are reset automatically. The alarm is deactivated as soon as the alarm condition ceases. Otherwise the user must follow the deactivation procedure once the alarm conditions is over.

When the alarm is eliminated the alarm relay is deactivated and the alarm code will no longer be displayed.

LED indication

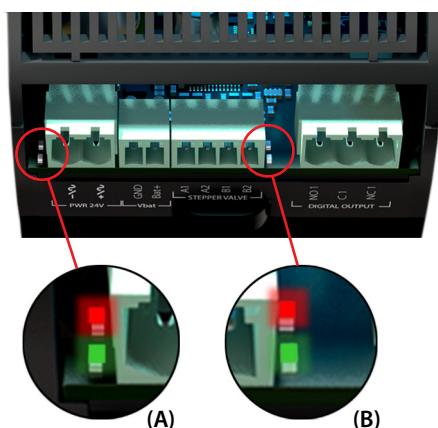

(A) Two status LEDs to indicate operational status

- Steady green = power ON
- Flashing green = data transmission / initialization
- Flickering red = alarm / error condition

(B) Two status LEDs to indicate valve operation

- Flashing red = valve closing
- Steady red = valve fully closed
- Flashing green = valve opening
- Steady green = valve fully open
- Both green and red flashing = valve-related alarm

25.2 Lack of valve capacity Alarm

Lack of Valve Capacity

Lack for capacity alarm can be used to get early warnings relating to a blocked condenser, a leak in the system or under sizing of the injection valve. The valve could also be stuck at low OD. It is considered abnormal, that the system needs to run at maximum OD for a long time.

A Lack of capacity alarm is generated if OD is above maximum OD -5% in 90% of the monitoring window operation. The alarm becomes inactive and the timer resets, when OD is below maximum OD -5% in 88% of monitoring window, or when control is OFF.

Note: This alarm is also active in the Hot Gas bypass application.

Parameter	Function	Description
A112	Lack of capacity alarm delay, in minutes	Length of monitoring window for Lack of capacity detection. If the parameter is set to 0 the function is disabled.

25.3 Superheat Alarm

Activation or deactivation of superheat alarm (High or Low) can be done by setting following Parameters.

Low superheat alarm

Parameter	Description
A987 - Low Superheat	Check details in alarm and Error table
[A110 - Low SH alarm delay]	Length of monitoring window for Low superheat detection. If the parameter is set to 0 the function is disabled.
[A998 - Low SH alarm differential]	The value subtracted from SH reference, which SH has to be below, to be defined as low: Low superheat limit= SH ref- Low SH alarm differential. If Low superheat limit is lower than SH close set point, then Low superheat limit= SH close set point. Also, Low superheat limit $\geq 2K$

High superheat alarm

Parameter	Description
A988 - High Superheat	Check details in alarm and Error table
[A108 - High SH alarm delay]	Length of monitoring window for High superheat detection. If the parameter is set to 0 the function is disabled.
[A109 - High SH alarm differential]	The value added to SH ref, that SH has to be above, to be defined as high: High superheat limit= SH ref+ High SH alarm differential.

26.0 Alarm and error table

Label	Modbus PNU	Bit No.	Alarm Description	Actions during active	Trigger (how the alarm is raised)	How to clear the alarm	Remark
CONFIGURATION ERRORS							
E101	1901	9	Configuration error	Auto operation blocked	Active when: - DI2 and DI3 have the same mapping configuration. - AI1 and AI5 have the same mapping configuration.	Correct application settings	One or more configuration errors is blocking operation to start. Check the other active alarms to identify the configuration problem
E011	1901	1	No refrigerant selected	Auto operation blocked	O030 refrigerant set to none	Set O030 refrigerant set to an actual refrigerant	No refrigerant is selected, configure the correct refrigerant. See "O030 Refrigerant"
E112	1903	12	AI5 not available on this variant	Auto operation blocked	Variant conflict EKE 1A has 1 temp. sensor	Change settings, so S3 and/or S4 is not used	EKE 1A only operate with 1 temperature sensor on AI2, please set I020 AI1 configuration = Not used
E113	1903	13	AI3 not available on this variant	Auto operation blocked	Variant conflict on EKE 1A and And B configuration problem EKE1C if PT1000	Set sensor for AI5 to be of NTC 10K type	EKE 1A and EKE 1B don't operate with 3 temperature sensors, please set I022 AI5 configuration = not used
E120	1903	4	AI1 not available on this variant	Auto operation blocked	Variant conflict NO DI3 on EKE 1B and 1C	Set DI3 configuration to "not used"	EKE1B and EKE 1C only operate with 2 DI. Please set O037 DI3 configuration = Not Used
E110	1903	10	Temp. offset is not available on this variant	Auto operation blocked	Variant conflict (not possible to do temp offset on EKE 1A)	Not set ext. ref configuration to "v->temp" or "mA->t"	EKE 1A don't include thermostat function. Therefore, offset of temperature set point via analogue signal is not possible. Don't set O010 Ext. ref. configuration to mA->Temp or V->Temp
E111	1903	11	MODbus is not available on this variant	Auto operation blocked	Variant conflict (not possible to use Modbus on EKE 1A)	Not set ext. ref configuration to "Modbus->temp" or "Modbus->SH" or for valve driver don't set driver reference configuration to Modbus-> OD/steps	EKE 1A don't include Modbus. Don't set O010 Ext. ref. configuration to Modbus->SH or Modbus->Temp
E104	1902	3	SH reference too close to SH close set point	Auto operation blocked	SH close is used and SH close set pint is too close the actual reference/ reference minimum	Disable SH close or correct the actual SH reference / reference minimum to have 0,5K difference to SH close set point	SH reference can come to close to the SH close safety functions et point, which can result in unstable operation. Keep min. 0,5K separation between minimum SH reference and N119 SH close set point.
E105	1902	4	LOP set point too close to MOP set point	Auto operation blocked	If MOP and LOP is used, Mop set point - Lop set point must > 5K	Disable MOP or LOP, or adjust the difference on MOP-LOP set point >= 5K	The set point for the 2 pressure safety function Lop and Mop is to close. Keep min. 5K separation between N011 MOP set point and N140 LOP set point
E129	1902	5	No sensor configured for S4	Auto operation blocked	Application need a S4 signal for either thermostat or Min S4, but S4 signal is configured	Disable the functions needing S4 or configure a S4 signal	Operation is configured to use S4 (media out) sensor, but no S4 sensor is configured, Correct I020 AI1 configuration or AI5 configuration and check I042 S4 sensor configuration
E106	1902	6	No sensor configured for S3	Auto operation blocked	Thermostat need a S3 signal and no s3 signal is configured	Disable the functions needing S4 or configure a S4 signal	Operation is configured to use S3 (media in) sensor, but no S3 sensor is configured, Correct I020 AI1 configuration or AI5 configuration and check I041 S3 sensor configuration
E107	1902	7	SH min higher than SH max	Auto operation blocked	SH max lower than SH low	Adjust SH max or SH low, SH Max >=SH low	N010 SH min. is set higher than N009 SH max..
E108	1903	8	OD min higher than OD max	Auto operation blocked	OD max lower than OD low	Adjust OD max or OD low, OD Max >=OD low	I066 Minimum OD is set higher than N032 Maximum OD
E109	1903	9	No transmitter configured for Pc	Auto operation blocked	Application need PC signal for high condensing temperature protection	Disable High condensing temperature protection or configure PC transmitter	Operation is configured to use Pc transmitter, but no Pc transmitter is configured. Correct I022 AI4 configuration and check I044 Pc transmitter configuration
E125	1903	4	AI5 can't operate with AKS sensor	Auto operation blocked	ON EKE1C AI5 configuration is setup as AKS sensor	Set AI5 configuration to the of NTC10K typew	EKE 1C don't support AKS sensor on AI5. Please use a temperature sensor on NTC type on AI5. Correct, I022 AI5 configuration
E132	1904	9	No sensor configured for S2	Auto operation blocked	S2 Sensor configuration = Not defined		No sensor type defined for S2
E133	1904	10	No transmitter configured for Pe	Auto operation blocked	Pe transmitter configuration = Not defined		No pressure transmitter type defined for Pe
E134	1904	11	Ext. ref. configuration error			Correct setting	Check the ext. ref. signal and the ext. ref. configuration.

Design Guide | Superheat controller type EKE 1A, EKE 1, EKE 1C

Label	MODbus PNU	Bit No.	Alarm Description	Actions during active	Trigger (how the alarm is raised)	How to clear the alarm	Remark
SENSOR ALARMS / ERRORS							
E024	1901	11	S2 suction pipe sensor error	Alarm if backup signal is found, error if no backup possible, emergency cooling	Local sensor problem local sensor outside range + hyst	Get the local sensor inside signal range	S2 suction pipe sensor signal is found to be out of out of range, please check connection and I040 S2 sensor configuration
E025	1901	12	S3 media inlet sensor error	Alarm if backup signal is found, error if no backup possible, emergency cooling	If S3 is used: local sensor problem local sensor outside range + hyst	S3 not used or get the local sensor inside signal range	S3 media inlet sensor signal is found to be out of out of range, please check connection and I041 S3 sensor configuration
E026	1901	13	S4 media outlet sensor error	Alarm if backup signal is found, error if no backup possible, emergency cooling	If S4 is used: local sensor problem local sensor outside range + hyst	S4 not used or get the local sensor inside signal range	S4 media outlet sensor signal is found to be out of out of range, please check connection and I042 S4 sensor configuration
E020	1901	14	Pe evaporator transmitter error	Alarm if backup signal is found, error if no backup possible, emergency cooling	Local sensor problem local sensor outside range + hyst	Get the local sensor inside signal range	Pe evaporator transmitter signal is found to be out of out of range, please check connection and I043 Pe transmitter configuration
E121	1901	15	Pc condenser transmitter error	Alarm if backup signal is found, error if no backup possible	Local sensor problem local sensor outside range + hyst	Pc not used or get the local sensor inside signal range	Pc transmitter signal is found to be out of out of range, please check connection and I044 Pc transmitter configuration
A982	1903	6	Thermostatic signal missing	Emergency Cooling thermostat	If thermostat is is used and S3 or S4 signal missing (depending on sensor select	Get valid signal on S3 or S4	Signal for thermostat is missing due to sensor errors, check S3 or S4
A981	1903	7	SH control signal missing	Emergency cooling SH control	Pe or S2 signal missing	Get valid signal on Pe and S2	Signal for superheat calculation is missing, check S2 and Pe
E019	1901	0	External reference signal alarm		External reference out of range + hyst	get external signal inside range	External offset/reference signal is out of range, please check connection and O010 Ext ref configuration and relevant high/low settings
A999	1903	0	DI1 unstable input	DI is set to off	DI is unstable, loose connection more than 10 transitions per minute	DI has stable low or high signal, below 6 transitions per minute	DI 1 is found be unstable (many on/off within a Short time). DI1 is set off until stable value is present. Check connection
A998	1903	6	DI2 unstable input	DI is set to off	DI is unstable, loose connection more than 10 transitions per minute	DI has stable low or high signal, below 6 transitions per minute	DI 2 is found be unstable (many on/off within a Short time). DI2 is set off until stable value is present. Check connection
A983	1903	7	DI3 unstable input	DI is set to off	DI is unstable, loose connection more than 10 transitions per minute	DI has stable low or high signal, below 6 transitions per minute	DI 3 is found be unstable (many on/off within a Short time). 3 is set off until stable value is present. Check connection
E102	1901	10	Sensor supply overload	Bios make power state on the actual supply, automatic operation blocked	Too much current draw on +5V 150mA+ or +15V (200mA+)	+5V below 50mA and +15V below 30mA	Sensor supply is overloaded. The output is set off until the load is reduced, Check for Short to COM
E123	1904	8	Low supply voltage	Operation is blocked (main switch is set to off; stepper is not operational)	Stepper voltage below 16V	Stepper voltage above 16V	Supply voltage is found to be lower than expected tolerance

Label	MODbus PNU	Bit No.	Alarm Description	Actions during active	Trigger (how the alarm is raised)	How to clear the alarm	Remark
STEPPER ALARMS / ERRORS							
E103	1901	2	No valve configured	Auto operation blocked	I067 valve configuration set none	I067 valve configuration set a valve from the list	No valve selected. Please configure the correct valve in I067 Valve configuration
E100	1901	8	Valve configuration error	Auto operation blocked	One or more stepper configuration errors	Correct stepper config	One or more valve configuration errors is blocking operation of stepper valve. Check the other active alarms to identify the valve configuration problem
E114	1903	10	check valve step mode vs positioning	Auto operation blocked	Stepper mode is full step and half as final is requested	If full step mode is wanted set final positioning to full. If half step as final position is wanted, set step mode to minimum half step	With I064 Valve step mode set to "full" and I029 Valve step positioning set Half step operation is possible, Correct either I029 or I064
E115	1903	11	Valve speed too fast	Auto operation blocked	Combination of step mode and speed give too few micro speed per sec (below 8)	Adjust valve speed and/or valve step mode to be with limits	Number of micro steps/sec is too high (higher than 12800 micro step/sec), Reduce I031 Valve speed or use less micro step per full step (I064 Valve step mode)
E116	1903	12	Valve speed too slow	Auto operation blocked	Combination of step mode and speed give too many micro speed per sec (higher than 12800)	Adjust valve speed and/or valve step mode to be with limits	Number of micro steps/sec is low (higher than 8 micro step/sec), increase I031 Valve speed or increase I032 Valve start speed or use more micro step per full step (I064 Valve step mode)
E117	1903	13	Valve emergency speed too fast	Auto operation blocked	Combination of step mode and speed give too few micro speed per sec (below 8)	Adjust valve speed and/or valve step mode to be with limits	Number of micro steps/sec is too high (higher than 12800 micro step/sec), Reduce I061 Valve emergency speed
E118	1903	14	Valve emergency speed too slow	Auto operation blocked	Combination of step mode and speed give too many micro speed per sec (higher than 12800)	Adjust valve speed and/or valve step mode to be with limits	Number of micro steps/sec is low (higher than 8 micro step/sec), increase I061 Valve emergency speed
E119	1903	15	Valve start speed too slow	Auto operation blocked	Combination of step mode and speed give too few micro speed pr sec (below 8)	Adjust valve speed and/or valve step mode to be with limits	Number of micro steps/sec is low (higher than 8 micro step/sec), increase I031 Valve speed or increase I032 Valve start speed or use more micro step per full step (I064 Valve step mode)
E126	1903	5	Valve Short circuit or driver too hot	Auto operation blocked, stepper will try to recover every 10 secs	Stepper driver report thermal SHUTDOWN,	Stepper driver has recovered from thermal overload	Valve driver is unable to drive valve. Check for SHort the coils or if ambient is higher than 60 °C
A997	1901	5	Battery critical low voltage		Battery input below 12V	Battery input above 12.2V	Battery voltage is found to be critical low, valve will not be closed in case of power fail. Replace battery /check connections
A996	1901	6	Battery too high voltage		Battery input above 27V	Battery input below 25V	Battery voltage is too high. Valve will not be closed in case of power fail. Replace battery with one of correct type (18-24V.).
W001	1901	7	Battery low voltage		Battery input below 17V	Battery input above 17.2V	Battery voltage is found to be low, replace battery.
E124	1903	3	Open circuit on valve	Auto operation blocked, stepper will try to recover every 10 secs	Stepper detect one or 2 open coils	Current in both coils match valve profile	Valve have an open circuit on one or more coils. Check connections to valve.
BUS ALARMS / ERRORS							
E122	1901	3	SHared signal timeout		One or more signals (S2, S3, S4, P0, PC) are not SHared through CAN within "CAN bus min. update interval" or modbus with "Modbus min. update interval seconds".	All needed signal is updated at right frequency	A needed control / sensor / reference signal via CAN bus is missing. Check CAN bus connection and operation of other CAN bus controllers.
E128	1901	4	Ext. ref. via modbus timeout	If bus signal via modbus	Bus ext. ref. needs to be updated within "Modbus min. update interval seconds".	Ext refernce signal updated within Modbus min. update interval	A needed control / sensor / reference signal via Modbus is missing. Check Modbus connection and operation of other Modbus controllers.

Design Guide | Superheat controller type EKE 1A, EKE 1, EKE 1C

Label	MODbus PNU	Bit No.	Alarm Description	Actions during active	Trigger (how the alarm is raised)	How to clear the alarm	Remark
-------	------------	---------	-------------------	-----------------------	-----------------------------------	------------------------	--------

APPLICATION ALARMS

A994	1902	8	Low S4 media outlet temperature		Injection active and Min S4 function active and S4 below MIN S4 set point - Low Min S4 band and Low Min S4 delay expired	Injection not active or Min S4 function disabled or S4 above MIN S4 set point - Low Min S4 band	Media out temperature is below alarm limit and alarm delay has expired.
A991	1902	11	High evaporation pressure (MOP)		Injection active and Mop active and Te higher than mop set point + MOP alarm differential and MOP alarm delay expired	Injection not active or Mop disabled or Te below mop set point + MOP alarm differential	Pe / Te is higher than alarm limit and alarm delay has expired.
A990	1902	12	Low evaporation pressure (LOP)		Injection active and Lop active and Te lower than lop set point - LOP alarm differential and Cond..temp alarm delay expired	Injection not active or Lop disabled or Te above lop set point + LOP alarm differential	Pe / Te is lower than alarm limit and alarm delay has expired.
A989	1902	13	High condensing temperature		Injection active and HCTP active and Tc above HCTP set point + Cond. temp.alarm differential and LOP alarm delay expired	Injection not active or HCTP disabled or Tc below HCTP set point + Cond. temp.alarm differential	Pc / Tc is higher than alarm limit and alarm delay has expired.
A988	1902	14	High superheat		Injection active and SH above SH reference + High SH alarm differential and High SH alarm delay expired	Injection not active or SH below SH reference + High SH alarm differential	Superheat is higher than alarm limit and alarm delay has expired.
A987	1902	15	Low superheat		Injection active and SH below SH reference - low SH alarm differential and low SH alarm delay expired	Injection not active or SH above SH reference - low SH alarm differential	Superheat is below alarm limit and alarm delay has expired.
A986	1902	0	Lack of valve capacity		Injection active and OD higher than max OD - 5% for more than 90 % of Lack of capacity alarm delay time	Injection not active or OD higher OD - 5% in less than 88 % for Lack of capacity alarm delay time	Valve is running close to full capacity for long time.

THERMOSTAT ALARMS

A993	1902	9	High temperature		Thermostat active and thermostat temperature (s4/S3) above actual reference + Upper temperature alarm for Temperature alarm delay time	Thermostat not active or thermostat temperature (s4/S3) below actual reference + Upper temperature alarm	Thermostat temperature is higher than alarm limit and alarm delay has expired
A992	1902	10	Low temperature		Thermostat active and thermostat temperature (s4/S3) below actual reference - lower temperature alarm for Temperature alarm delay time	Thermostat not active or thermostat temperature (s4/S3) above actual reference - lower temperature alarm	Thermostat temperature is lower than alarm limit and alarm delay has expired

STOP STATE ALARM

W002	1902	1	Standby mode		Controller is in stop state	Controller not in stop state	The controller is standby due R012 Main switch and/or DI main switch is off
------	------	---	--------------	--	-----------------------------	------------------------------	---

MANUAL MODE ALARM

W003	1902	2	Manual control		Controller is in manual state	Controller not in manual state	The controller is manual control, no automatic control is active and many alarm are disabled
------	------	---	----------------	--	-------------------------------	--------------------------------	--

25.0 Trouble shooting

ID	Symptom	Possible cause / Reaction	Solution
1	Regulation does not start on using control modes i.e. MSS	DI is not connected, if defined as ON/OFF hardware switch.	• Turn on DI switch.
		Sensor / transmitter error.	• Check and clear alarm.
		Alarm configuration conflict i.e. S2 sensor not defined or no refrigerant selected.	• Clear and clear Alarm.
		Alarm: standby mode active i.e. Parameter R012 is OFF.	• Set R012 main switch to 1.
2	Suction pressure too low	Pressure drop across evaporator too high.	<ul style="list-style-type: none"> • Check refrigerant ahead of expansion valve. • If valve is placed much higher than condenser outlet. • Check pressure difference.
		Lack of sub cooling ahead of expansion valve.	<ul style="list-style-type: none"> • Limit max opening degree of the valve setting in controller. • Check refrigeration system capacity and compare with expansion valve capacity. • Use proper valve size.suitable for the system.
		Evaporator superheat too high.	• Check the section " High Superheat ".
		Pressure drop across the expansion valve less than valve is sized for.	<ul style="list-style-type: none"> • Check pressure drop across expansion valve. • Replace with larger valve.
		Expansion valve too small.	<ul style="list-style-type: none"> • Check refrigeration system capacity and compare with expansion valve capacity. Replace with larger valve if necessary. • Check selected valve type in the controller valve list.
		Expansion valve block with foreign material.	• Remove valve and examine the orifice /piston.
		Wrong selection of Refrigerant in the controller settings.	• Choose the correct Refrigerant from the pre-defined list.
		Lack of Charge in the system.	<ul style="list-style-type: none"> • Charge the system with appropriate refrigerant capacity. • Check for leakage in the system.
		Pressure transmitter ranges or type is wrongly defined.	• Define the correct pressure range.
		MOP set point is defined very low.	• Check the MOP setting, if Modbus is used, check if the values have been scaled as indicated in the parameter list.
		Evaporator wholly or partly iced up.	• De-ice evaporator.
		Low chilled water flow	• Check flow as per design
chilled water temp too low	• Check temp set points as per design		
3	Low pressure cut out due to compressor cut in and cut out	Missing start signal.	• Check for digital input DI signal or its settings.
		Startup problem.	• Check section start- up problem and its solution.
4	Liquid hammer in compressor (noisy or unusual compressor sound) and /or frost on the suction line	Superheat reference set too low.	• Increase the SH reference by changing the SH min. max. parameter.
		Superheat is too low.	<ul style="list-style-type: none"> • Make sure SH Close function is ON. • Increase the values of SH close and SH min. • Also check section "Too low superheat".
		Inaccurate SH measurement or slow response in S2 sensor.	<ul style="list-style-type: none"> • Ensure that S2 sensor is secured on suction line. • Insulate temperature sensor properly. • Check the product installation guide section temperature sensor.
		Refrigerant or pressure transmitter is not set correctly.	• Check the related parameters.
5	Too Low superheat	Min. SH parameter is too low set.	• Raise the min. SH parameter.
		Valve Cannot Close fully.	• Reduced the Valve OD or forced opening time at Start up.
		Valve OD too large at start up.	<ul style="list-style-type: none"> • Use P-control. • Reduce Start OD.
		Inaccurate superheat.	• Mounting position of Temperature sensor. Place sensor close to evaporator.
		High pressure drop in suction line.	<ul style="list-style-type: none"> • Mounting position of the pressure transmitter. Place the transmitter close to evaporator. • Check the product installation guide section temperature sensor.
		Valve is stuck at open.	• Check valve installation.
		Liquid returns to compressor.	• Check section Liquid hammering.

Design Guide | Superheat controller type EKE 1A, EKE 1, EKE 1C

ID	Symptom	Possible cause / Reaction	Solution
6	High superheat	Lack of sub-cooling.	<ul style="list-style-type: none"> Limit max opening degree of the valve setting in controller. Check refrigeration system capacity and compare with expansion valve capacity. Use proper valve size suitable for the system.
		Controller is not setup/tuned properly.	<ul style="list-style-type: none"> Check the controller superheat settings SH min., max. and sensors connected to it. Tune PID parameters in the controller.
		Wrong valve selected from the controller list or undersized valve installed.	<ul style="list-style-type: none"> Check the right valve type and setting or use the appropriate valve size for the needed condition.
		Seasonally high load condition or overloaded the system.	<ul style="list-style-type: none"> Check the heat exchanger for dirt's. Check superheat performance.
7	Too high or too low measured superheat	Wrong sensor type, refrigerant type, pressure transmitter type and/or range.	<ul style="list-style-type: none"> Check the related setting and range. In case of offset in sensor or pressure transmitter, perform the sensor correction.
			<ul style="list-style-type: none"> Always use accurate pressure transmitter
8	a. Measured Superheat is higher than reference - more than 5K for 5 - 10 min.	Load condition has changed and the superheat controller is too slow to adapt to the change.	<ul style="list-style-type: none"> TN can be adjusted to 20% lower and Kp can be adjusted to be 20% higher, monitor that the adjustment don't make the valve OD and Pe/Te oscillate.
		Compressor capacity has changed and the superheat controller is too slow to adapt to the change.	<ul style="list-style-type: none"> Compensation for compressor change is done with KpTe in this case KpTe can be adjusted to be 20% higher.
		Missing valve capacity.	<ul style="list-style-type: none"> Check if valve OD is close to 100 %, if so the valve is missing capacity , check if sub cooling is OK. System might have loss charge.
	b. Measured Superheat is lower than reference - lower 3K	SH close parameter is disabled or not setup optimally.	<ul style="list-style-type: none"> Enable the SH close function and set the setpoint 2K below the reference.
		Compressor capacity has changed and the superheat controller is act too aggressive to adapt to the change.	<ul style="list-style-type: none"> Compensation for compressor change is done with KpTe in this case KpTe can be adjusted to be 20% lower.
9	Fluctuating superheat	The S2 sensor not in good contact with the suction line.	<ul style="list-style-type: none"> Check proper mounting of the temperature sensor.
		Fast change in load and ambient condition.	<ul style="list-style-type: none"> Wait for the stable condition and check again.
		Periodic flash gas at the valve inlet.	<ul style="list-style-type: none"> Secure stable sub cooling.
		Aggressive gain Kp and Kp Te parameter.	<ul style="list-style-type: none"> Decrease gain in the controller, ex set SH Tn to be 20 % higher and reduce Kp 20%, if still SH is fluctuating, reduce KpTe by 20%. Try with the higher SH reference.
10	Negative superheat	Wrong sensor type, refrigerant type, pressure transmitter type and range.	<ul style="list-style-type: none"> Check the related setting and range.
		During start up suction pressure is low because of low Ambient temperature.	<ul style="list-style-type: none"> Check the startup problem.
		System is not running.	<ul style="list-style-type: none"> Check the system.
11	Superheat outside the defined range or does not reached the setpoint	Wrong valve selected or its valve parameter.	<ul style="list-style-type: none"> Check the right valve type and its setting.
		Loss of refrigerant in the system.	<ul style="list-style-type: none"> Charge the system with appropriate refrigerant capacity. Check for leakage in the system.
		Expansion valve too small.	<ul style="list-style-type: none"> Replace with larger valve if necessary. Check the selected valve in the controller valve list.
		Step loss in the valve.	<ul style="list-style-type: none"> Drive the stepper valve with the recommended Speed. Too high or too low speed could result in loss step in the valve. For the user defined valves, check the other valve settings such as current, duty cycle, holding current and other relevant parameter.
			<ul style="list-style-type: none"> Use overdrive features to mitigate the loss steps. Use the correct overdriving values with respect to the used value.
			<ul style="list-style-type: none"> Wrong defined valve type or its setting.
			<ul style="list-style-type: none"> Longer cables mounted than specified for the controller. Separate Valve cable from other high power cables and do not bundle the cables.
<ul style="list-style-type: none"> Blockage in the valve or high friction in the valve. 			
<ul style="list-style-type: none"> MOPD exceeded than specified in the valve specification. 			

ID	Symptom	Possible cause / Reaction	Solution
12	Takes too long to settle SH at reference point	Too low gain Kp and KpTe or long integration time Tn.	<ul style="list-style-type: none"> 1. Increase Kp by factor of 1.5. 2. Decrease Tn 25% of the set value. Perform 1 and 2 in loop if needed.
		At start up, the pull down time for SH or temp. is longer.	<ul style="list-style-type: none"> Use start with P - control and increase start OD. If the superheat in general is 4K higher than reference 1 minute after start up , the startup OD can be adjusted to be 20 % higher.
		Wrong selection of the valve.	<ul style="list-style-type: none"> Check the valve type and its setting.
		Wrong selection of the reference point.	<ul style="list-style-type: none"> Correctly define the min, max SH setting and/or reference type i.e MSS/Load defined ap / Fixed/delta Temp. Also check section , High superheat and 'Too high and too low superheat'
13	Start up problem	Low pressure cut out at start up.	<ul style="list-style-type: none"> Check the LED Alarm connection. Missing synchronization with controller and the compressor i.e. DI not connected to EKE. Wrong or missing valve connection, Check the M12 cable connection to the valve and to the controller. Check other component in the suction or liquid line for any kind of blockage. Use the LOP feature during start up.
		Unsynchronized signals.	<ul style="list-style-type: none"> Make sure that main switch signal and the compressor start are synchrony, it ok to have until 2 sec delay.
		High Superheat after startup.	<ul style="list-style-type: none"> Check section Too high or too low superheat.
14	Startup problem after defrost	Low suction cut out	<ul style="list-style-type: none"> Use EKE defrost sequence feature. Use LOP feature. Use P- control at start method and prolong the start time. Check the right signal from the controller.
15	Unable to maintain media temperature	Lack of sub-cooling ahead of expansion valve.	<ul style="list-style-type: none"> Limit max. opening degree of the valve setting in controller. Check refrigeration system capacity and compare with expansion valve capacity. Use proper valve size suitable for the system.
		Check section High superheat, and Low suction pressure.	
		Wrong selection of temperature sensor and or installation.	<ul style="list-style-type: none"> Check for the right sensor configuration.
		Check Working condition of the unit	<ul style="list-style-type: none"> Check Superheat.
16	Flash gas	Loss of refrigerant or undercharge of refrigerant.	<ul style="list-style-type: none"> Charge the system with appropriate refrigerant capacity. Check for leakage in the system. If the valve is placed much higher than condenser outlet, check pressure difference.
		Flash gas can lead to high SH or low suction pressure.	<ul style="list-style-type: none"> use the right valve size. Also refer to section "High Superheat" and "Suction pressure too low".
		Pressure drop across filter.	<ul style="list-style-type: none"> Check and replace the filter.
17	Stepper valves open / close too slow	Incorrect selection of valve type.	<ul style="list-style-type: none"> Define the correct valve type.
		Incorrect valve installation.	<ul style="list-style-type: none"> Check the physical valve and cable and install it in right way.
		MOPD is higher than valve specification.	<ul style="list-style-type: none"> Check the valve spec and choose the correct valve.
		Check valve speed setting.	<ul style="list-style-type: none"> Drive the stepper valve with the recommended Speed. Too high or too low speed could result in loss step in the valve. For the user defined valves, check the other valve settings such as current, duty cycle, holding current and other relevant parameter.
17	Opening degree of valve at maximum OD for longer time period	Lack of cooling capacity.	<ul style="list-style-type: none"> Check the cooling capacity in the system Also check section, expansion valve too small.
		The condenser pressure is too low.	<ul style="list-style-type: none"> Check the ambient temperature. Adjust the condenser controller.
		The filter drier is blocked by dirt.	<ul style="list-style-type: none"> Replacement Filter drier.
		Flash gas in liquid line due to loss of refrigerant or undercharge of refrigerant.	<ul style="list-style-type: none"> Check section Flash gas.
		Wrong valve settings.	<ul style="list-style-type: none"> Check valve setting matching installed valve.
		Pressure transmitter is wrongly defined or selected wrong type.	<ul style="list-style-type: none"> Check pressure range and correct pressure transmitter type.
		Wrong refrigerant selected.	<ul style="list-style-type: none"> Choose the correct refrigerant in the controller.

ID	Symptom	Possible cause / Reaction	Solution
18	Hunting or fluctuation valve position	Too high gain (Kp and KpTe) or too low integration time (Tn).	<ul style="list-style-type: none"> 1. Decrease Kp by factor of 1.5. 2. Increase Tn 25% of the set value. Perform 1 and 2 in loop if needed.
		s2 thermal contact.	<ul style="list-style-type: none"> Check mounting of S2 sensor, Check the installation guide section temperature sensor mounting.
		Fluctuating AI signal for SH reference.	<ul style="list-style-type: none"> Check AI signal quality.
		Fluctuating pressure signal.	<ul style="list-style-type: none"> Check section Fluctuating pressure signal.
		Fluctuating Superheat.	<ul style="list-style-type: none"> Check section Fluctuating Superheat.
19	Unstable OD on driving the valve in Valve driver mode	Fluctuating AI signal.	<ul style="list-style-type: none"> Check the AI signal quality. Use the Valve neutral zone feature.
20	Internal Leakage in the valve	Wrong selection of the valve.	<ul style="list-style-type: none"> Check the valve type and its setting.
		Step loss in stepper motor valve.	<ul style="list-style-type: none"> Power cycle the controller. Enable the step loss feature i.e. overdriving, choose the recommended overdrive value with respect to the installed valve.
			<ul style="list-style-type: none"> Drive the stepper valve with the recommended speed. Too high or too low speed could result in loss step in the valve.
			<ul style="list-style-type: none"> Longer cables mounted than specified for the controller. Separate Valve cable from other high power cables and do not bundle the cables.
			<ul style="list-style-type: none"> Blockage in the valve or high friction in the valve. MOPD exceeded than specified in the valve specification.
21	Valve does not move	Valve neutral zone has been defined.	<ul style="list-style-type: none"> Check Valve parameter in chapter Stepper motor valve.
		Loose or incorrect M12 cable connection.	<ul style="list-style-type: none"> Check proper and firm connection of valve cable wires to EKE terminals. Also check section 'valve rotates in opposite direction'.
		Change in valve setting or other configurations.	<ul style="list-style-type: none"> Check for the correct valve parameters. Check for the correct state of r12 ON/OFF regulation or DI connection. IF AI or Modbus signal is used, make sure that the correct signal is connected to the controller.
		Incorrect voltage supplies to the controller.	<ul style="list-style-type: none"> Check the power supply and measure input voltage to the controller.
		Valve got stuck.	<ul style="list-style-type: none"> Check the valve installation. Check for the dirt inside the valve.
		Valve motor is damaged; resistance of the motor varies a lot than specified for a valve.	<ul style="list-style-type: none"> Check the resistance in the motor between each coil. Make sure you consider some tolerances for cable or temperature deviation. Replace a valve.
22	Valve rotates in opposite direction	Valve M12 cable wire is wrongly connected to the controller.	<ul style="list-style-type: none"> Check the connection of wire color codes as stated in Installation guide. For other valves than Danfoss, check with valve supplier for the right connection.
		Wrong connection of wires at cable joint, if there is extension cable to the main Valve cable.	<ul style="list-style-type: none"> Check for the right color configuration at the joint.
23	Valve is overdriven to Zero position	EKE performs valve calibration in the following situation as a normal procedure.	<ul style="list-style-type: none"> Normal operation
		a. on defining a valve type.	
		b. Valve overdrive feature is enabled and OD is closed to fully closed position or the overdriving timer is ON.	
		c. Alarm or Error condition will bring the valve to Zero position and stop regulation	
	d. on setting DI = Off when DI is set as ON/OFF regulation		

Design Guide | Superheat controller type EKE 1A, EKE 1, EKE 1C

ID	Symptom	Possible cause / Reaction	Solution
24	Fluctuating pressure signal	Change in load of the system.	• Observe the change in the load of the system.
		Faulty pressure sensor.	• Replace faulty pressure transmitter.
		Flash gas in the system.	• Check the section flash gas.
25	Compressor thermal cut out (Mop is not working or going higher than set value)	MOP is not enable, or wrongly defined.	• Check mop settings.
		Change in operating condition.	• Observe the operating condition. • Controller need time to adjust to the stable condition.
26	LOP protection doesn't work at low pressure	if low superheat and low suction pressure exist same time for some time, LOP function is disabled.	• Check operating condition and settings.
		Fast change in operating condition.	• Controller need time to adapt to the change condition.
27	Controller is in safe state (check LED or display)	Internal error i.e. eeprom error in controller software exceptions.	• The controller must be power cycle, if continue to get the same error then replace controller.
28	Controller freeze. nothing happens	loose connections.	• Check the connection in the EKE.
		Incorrect voltage supplies to the controller.	• Check the power supply and measure input voltage to the controller. • Power cycle controller and observe the LEDs, IF no LEDs are not lighting during power cycle, replace controller.
29	No communication (Indicated by LEDs)	Wrong Modbus settings.	• Check Modbus address, baud rate, and protocol. • EKE only supports Modbus RS 485 RTU, it does not support Modicon conventions.
		Loose connection or no termination.	• Check the Modbus terminals and use terminations.

Appendix

Appendix 1

Acronyms and abbreviations used in this document.

Full name	Abbreviation
Compressor	Comp.
Capacity	cap
Controller	cont
Actual	act
Temperature at evaporator outlet	S2
Media inlet temperature	S3
Media out temperature	S4
Saturated temperature in evaporator	T_e / T_0
Pressure in evaporator	P_e / P_0
Saturated temperature in condenser	T_c
Pressure in condenser	P_c
Proportional gain constant	K_p
Integration time	T_n
Proportional gain constant on saturated temperature	$K_p T_e$
Opening degree	OD
Superheat	SH
Minimum	Min.
Maximum	Max.
Reference	Ref.
Temperature	Temp.
Factor	Fac.
Oscillation	Osc.
Condensator	Cond.
Feed forward	FF
Set point	Sp.
Ratiometric	Ratio.
Extern	Ext.
Address	Adr.
Pulse per second	PPS
Step	Stp
Loss of charge indication	LOC
Temperature difference between media temperature and evaporating temperature	ΔT_m
Maximum operating pressure	MOP
Minimum stable superheat	MSS
Parameter number	PNU

Appendix 2

General comparison between AKS and NSK Pressure transmitter

General comparison	AKS	NSK
Accuracy in the compensation temp. range (0 - 80 °C)	± 1%	> ± 2.5%
EMC	*****	***
Reliability /Robust	*****	***
Flexibility / connection options	****	**

***** indicates Best , and
* indicates worst .

Appendix 3

Accessing the BIOS menu (LCD display only)

MMIGRS2 Display setting

By pressing simultaneously the ESC and ENTER keys for 5 seconds at power up, you enter into a special BIOS menu; you can go through the voices of the menu using the UP and DOWN keys. confirm your selection with the ENTER key or discard it with the ESC key.

The menu is as follows:

APPLICATION:	to exit the bios menu and return to the application
DISPLAY:	to access the display setting menu
CONTRAST:	to set the LCD contrast; LEFT=decrement. RIGHT=increment
BRIGHTNESS:	to set the LCD brightness; LEFT=decrement. RIGHT=increment
POS / NEG:	to switch between positive and negative display using the ENTER key
BUZZER:	to set the buzzer volume and disable it; UP=increment. DOWN=decrement
CAN:	to access the CAN communication configuration menu.
NODE ID:	to set the device address on the CAN network; UP=increment. DOWN=decrement
BAUDRATE:	to set the device baud rate on the CAN network (from 10 K to 1 M)

Appendix 4

Defining new refrigerant

Most of the used common Refrigerants have been defined as a pre selectable profile under "Refrigerant list para O030". for unlisted refrigerants, a "user defined refrigerant" can be use.

This is the procedure using KoolProg PC Tool

1. Find Refrigerant constants A1, A2 and A3
2. Set Main Switch in controller (.. 12) to "0", IF DI switch has been enabled as ON/OFF, set it to OFF
3. Select Refrigerant (O030) to "13"
4. Set the three constants for A1, A2 and A3, under parameter O0100, O0101, O0102
5. Set the min and max refrigerant temperature under parameter O0103 and O0104. If you don't have this value then use the default settings.
6. Set all other necessary settings
7. Set Main Switch to "1" enabling the controller to start running.



Note:

Before starting to define this new refrigerant. It is important to get the Ant A1, A2, A3 for the refrigerant from Danfoss

This is the procedure using MMIGRS2 display

1. Find Refrigerant constants A1, A2, A3
2. Activate the display by pushing a button
3. Push and hold "Enter"
4. Insert Password to access the Main menu
5. Go to "Start / Stop" and set main switch OFF
6. Go back to Main menu with "Escape" button
7. Go to Control Basic
8. Go to Refrigerant type and select "User defined"
9. Set the three constants for A1, A2 and A3, under parameter O0100, O0101, O0102
10. Set the min and max refrigerant temperature under parameter O0103 and O0104. If you don't have this value then use the default settings.
11. Set all other necessary settings
12. Set main switch to ON enabling the controller to start running.

Appendix 5

In applications with flammable refrigerants it is recommended to install a safety fuse of 2.5 Amp per Motor coil for ETS Colibri® valves in accordance to IEC 60127.

Flammable application

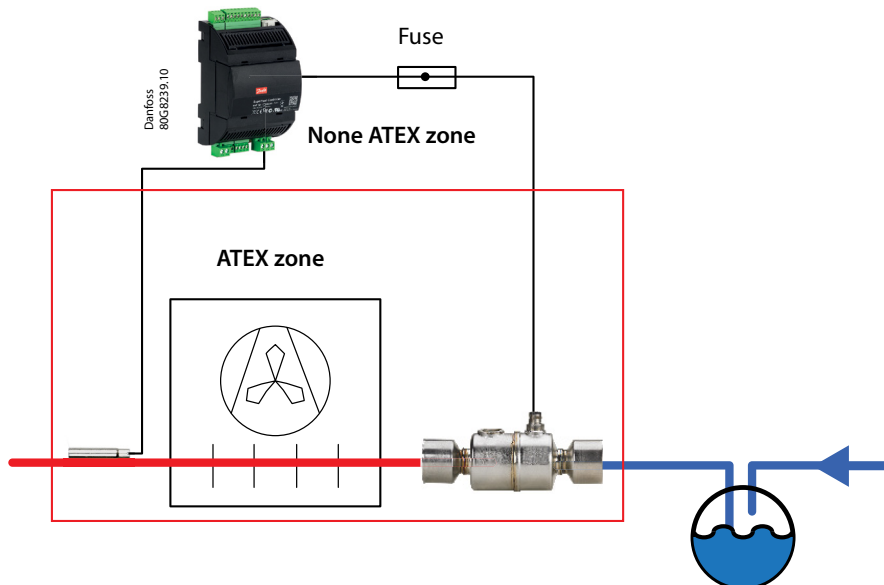

Appendix 6

Factory reset will triggered by the parameter [B007 – Apply defaults], which will reset to '0' after power up and after Factory Reset. Some parameters related to serial bus communication will not be changed during Factory Reset. Some other parameters i.e Language selection and history of Cut-in and Cut-out time for the thermostat will remain unchanged.

Factory Reset

Appendix 7

Overdrive enable

The opening degree needs to be above this value, before the overdrive will become enabled. When the overdrive is enabled the valve will overdrive once it is closed to 0%. The amount of extra steps is defined by the parameter [I072 - Overdrive] and is scaled as a percentage of the full opening. The parameter [I073- Overdrive Enable OD] defines how much the valve must have been open before overdrive is done at next close position and is scaled as a percentage of full opening.

To compensate for lost steps, the valve will be overdriven when it closes to 0%. i.e. it will close with extra steps to make sure that it is fully closed. This may however lead to increased wear on the valve if it occurs frequently. To prevent this, the overdrive enable can be set to a higher value. Please note that if the opening degree never goes above the overdrive enable level, overdriving may never be enabled, possibly leading to accumulated lost steps. Every time an overdrive has been performed, overdriving will be disabled until the opening degree again is above the overdrive enable level.

Actual opening degree

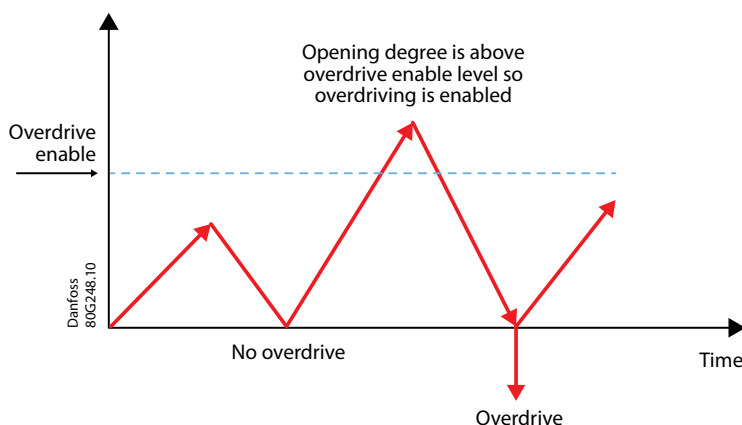

Overdrive block time

To limit how frequent overdrive can be performed the parameter [I074 - Overdrive block time] defines the minimum time between 2 overdrive actions. The default value is 10 minutes.

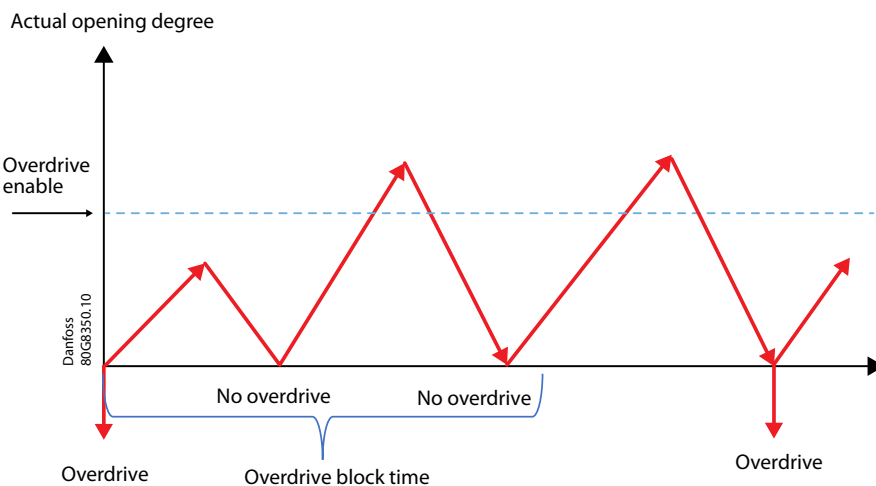

Initial closing

The driver will perform the initial closing after

- Power up
- When the total number of steps changes
- When the drive pattern changes (full/half step as final position)

The driver does not have to perform the initial closing at power up when it knows that the valve is closed e.g. after power failure and successfully emergency close.

Operation:

The valve is driven the total number of steps + overdrive in close direction.

Actual opening degree

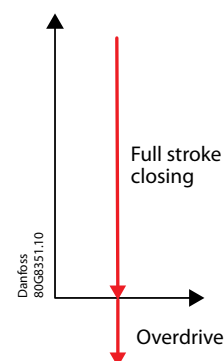

Appendix 8 Typical EKE 1A, 1B, 1C applications with Stepper motor valve.

A. Chiller (cooling only)

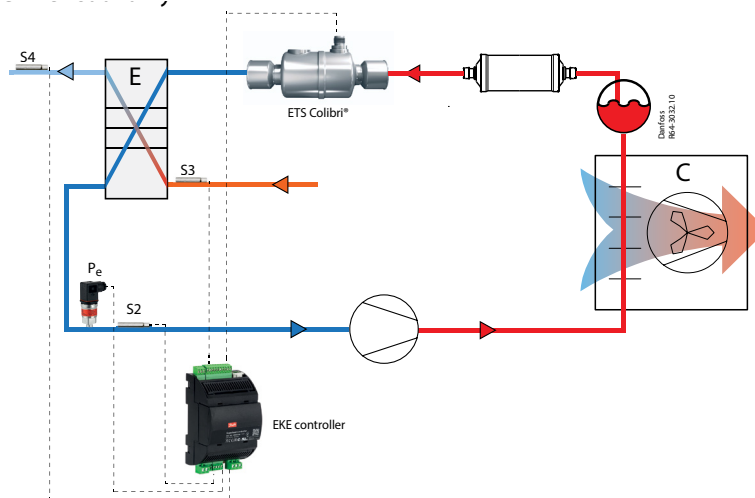

B. Reversible chillers (Air to water)

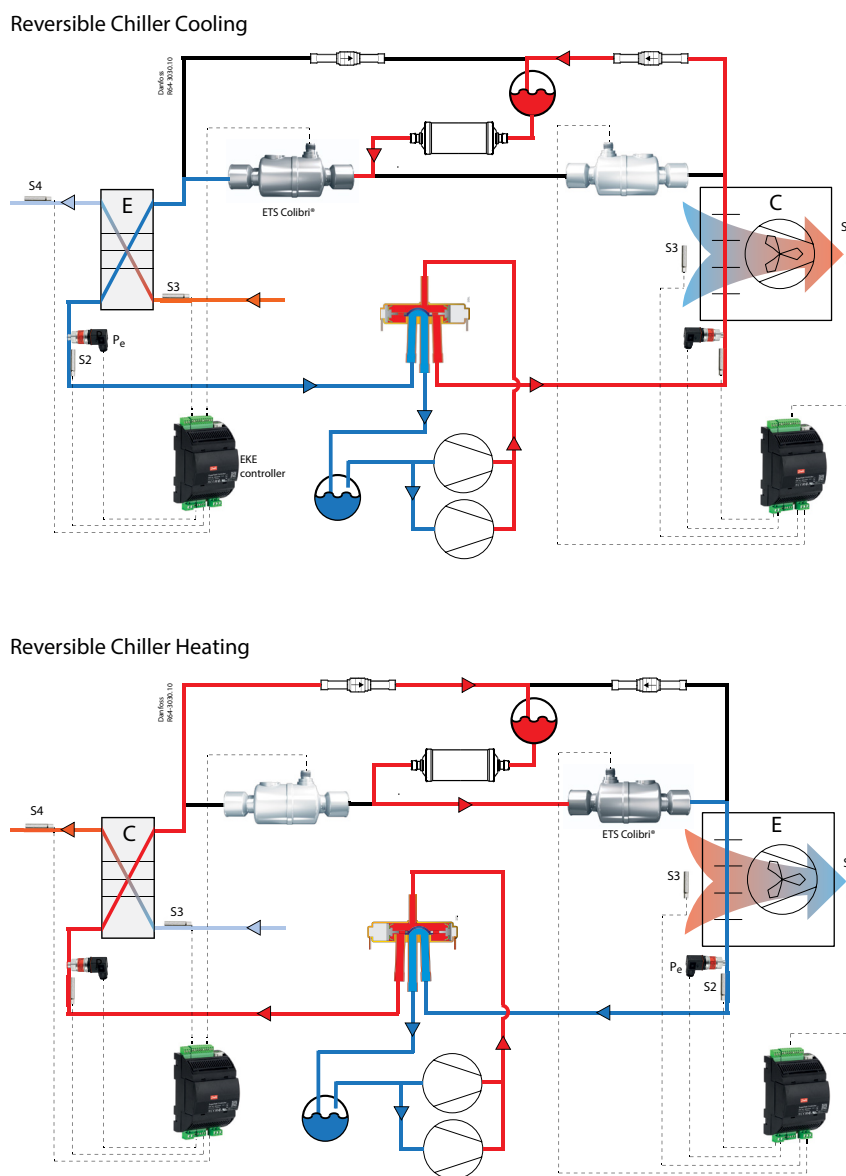

C. Reversible heat pump Air to water heat pump cooling

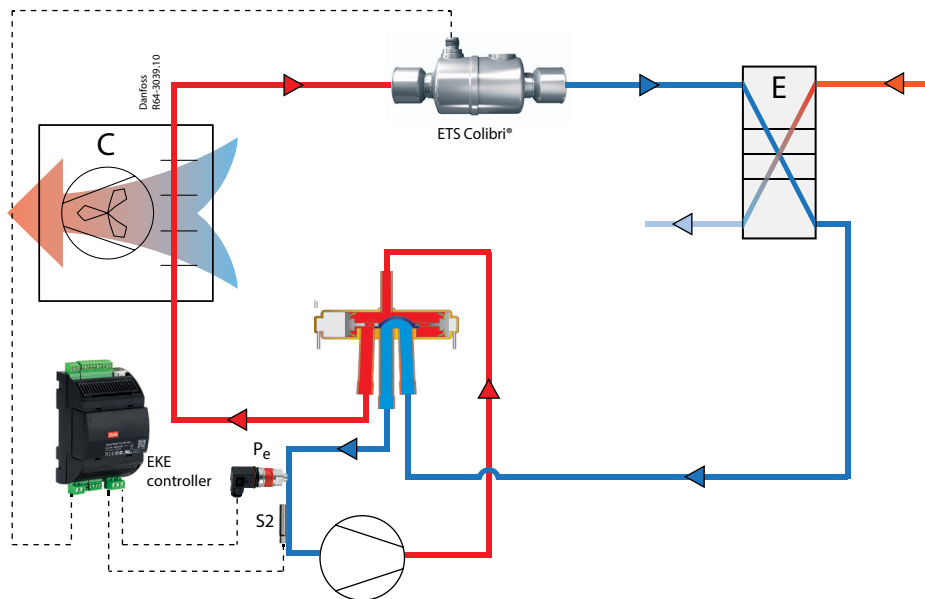

Air to water heat pump heating

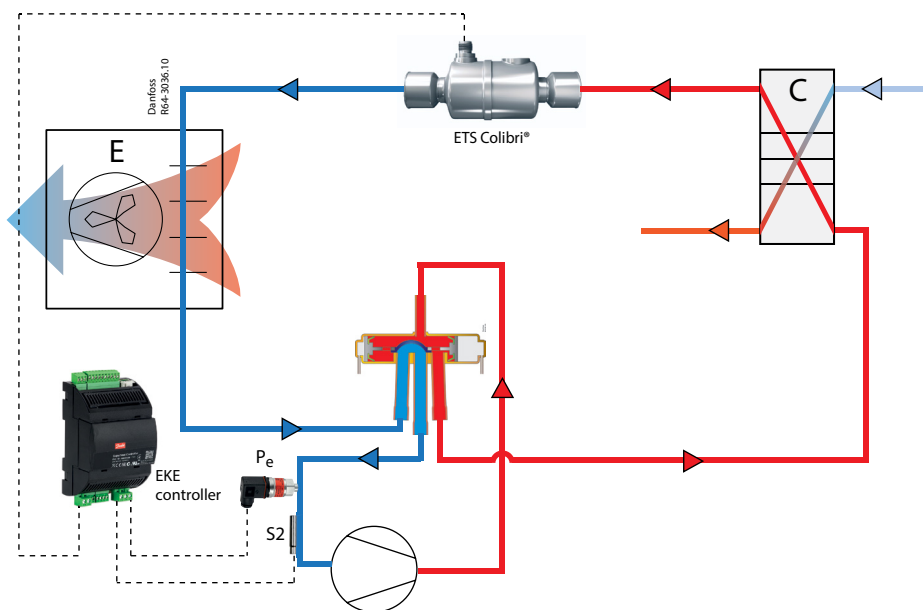

D. AC air handler

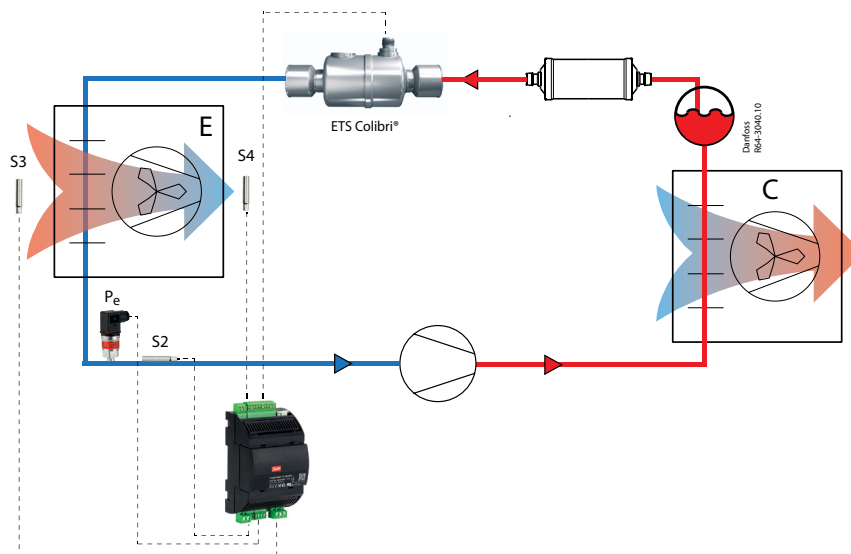

E. Cold room

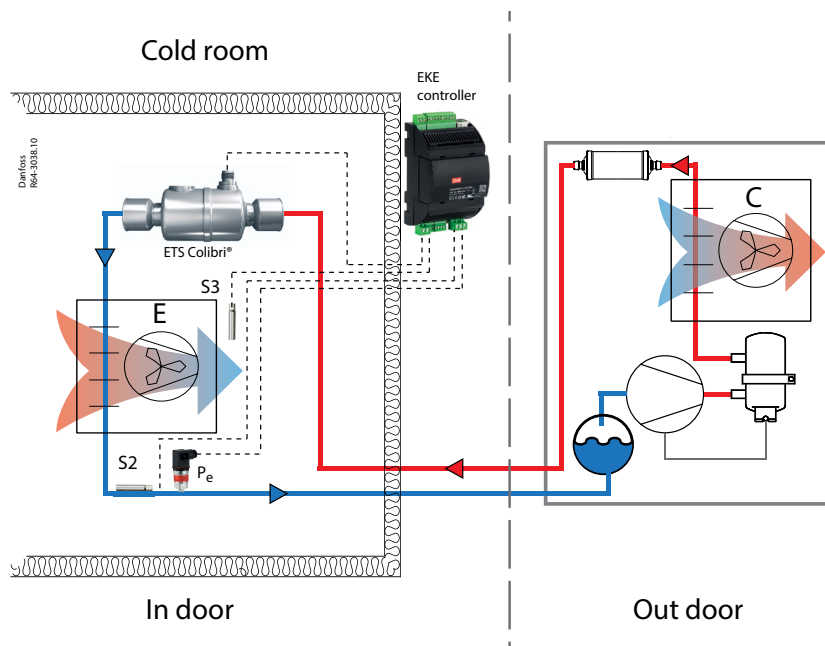

F. Multi evaporator

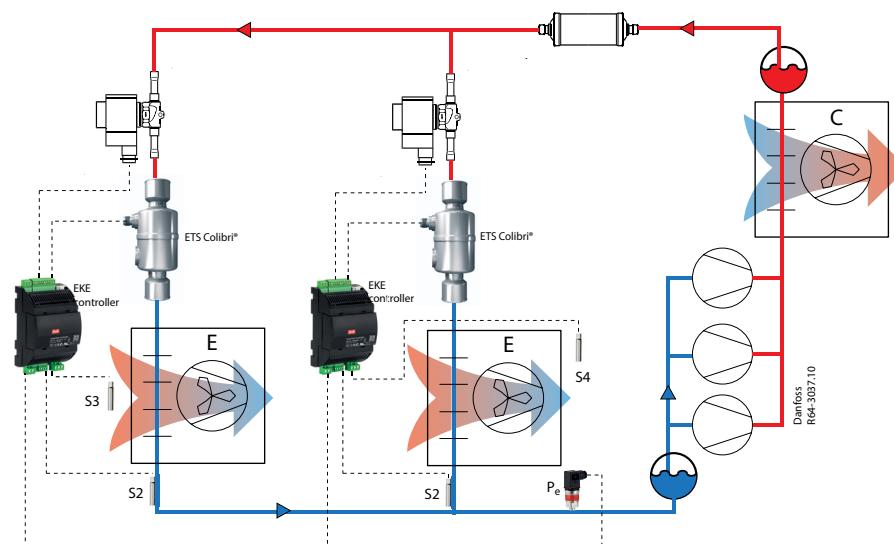

Appendix 9
Parameters List Explanations

Warning:
In modbus Values are read / written as 16 bit integer values without decimals. The values may need to scale as shown on the table.

Parameter	Name and abbreviation
PNU	The Parameter Number Note: this is equivalent to the MODBUS register number (modbus address + 1)
R/W	R means read only. RW means it can be changed
Locked by mainswitch	If the parameter is config locked it means that the value can only be changed when the main switch is OFF
Default	The default value of the parameter (factory setting)
Par. min./Par. max.	Parameter minimum and Parameter maximum range.
Par. Scale	This shows the scaling factor of the value *1) means that there is no scaling *10) means that the read value is 10 times larger than the actual value

Group	Par. name	Unit	PNU	Par. scale	Default	Par. min.	Par. max.	Access	Locked by mainswitch	EEPROM	Remark
-------	-----------	------	-----	------------	---------	-----------	-----------	--------	----------------------	--------	--------

Reference

Refrigeration on/off	R012 Main switch		3001	1	0	0	1	RW	x	✓	0 = Off 1 = On
	R102 Operation mode		1002	1	0	0	1	RW	✓	✓	0 = SH control 1 = Valve driver
Application configuration	R100 Compressor capacity		4001	10	0	0	100	RW	x	x	
	R015 Sensor select		3004	1	0	0	1	RW	✓	✓	0 = S3 1 = S4
Temperature control	R014 Thermostatic mode		3005	1	0	0	2	RW	✓	✓	0 = Not Used 1 = CutIn/CutOut 2 = MTR
	R101 Temperature setpoint	°C	3006	1	3	-70	70	RW	x	✓	
	R001 Differential	K	3007	10	2	0.1	10	RW	x	✓	
	N100 MTR Tn		3015	1	1800	20	3600	RW	x	✓	
External reference signal	N101 MTR Kp		3016	10	2	0.2	20	RW	x	✓	
	R006 Ext. ref offset max.	K	3008	10	0	0.0	50	RW	x	✓	
Sensor/transmitter correction	R106 Ext. ref offset min.	K	3009	10	0	-50	0	RW	x	✓	
	R009 S2 Correction	K	3010	10	0	-10	10	RW	x	✓	
	R010 S3 Correction	K	3011	10	0	-10	10	RW	x	✓	
	R105 S4 Correction	K	3012	10	0	-10	10	RW	x	✓	
	R107 Pe Correction	barg	3013	10	0	-5	5	RW	x	✓	
	R108 Pc Correction	barg	3014	10	0	-5	5	RW	x	✓	

Valve configuration

Valve setup	I067 Valve configuration		3132	1	0	0	32	RW	✓	✓	0 = no valve 1 = UserDef 2 = ETS 12C 3 = ETS 24C 4 = ETS 25C 5 = ETS 50C 6 = ETC 100C 7 = ETS 6 8 = ETS 12.5 9 = ETS 25 10 = ETS 50 11 = ETS 100 12 = ETS 250 13 = ETS 400 14 = KVS 2C 15 = KVS 3C 16 = KVS 4C 17 = KVS 15 18 = KVS 42 19 = CCMT 0 20 = CCMT 1 21 = CCMT 2 22 = CCMT 4 23 = CCMT 8 24 = CCMT 16 25 = CCMT 24 26 = CCMT 30 27 = CCMT 42 28 = CCM 10 29 = CCM 20 30 = CCM 30 31 = CCM 40 32 = CTR 25
	I027 Valve motor type		3133	1	0	0	1	RW	x	✓	0 = Unipolar 1 = Bipolar
	I028 Valve drive current	mA	3134	1	10	10	1000	RW	x	✓	
	I029 Valve step positioning		3135	1	0	0	2	RW	x	✓	0 = Fullstep 1 = Halfstep
	I030 Valve total steps	stp	3136	1	1	1	8000	RW	x	✓	
	I031 Valve speed	PPS	3137	1	10	10	400	RW	x	✓	
	I032 Valve start speed	%	3138	1	20	1	100	RW	x	✓	
	I061 Valve emergency speed	%	3139	1	100	50	200	RW	x	✓	
	I062 Valve acceleration current	%	3140	1	100	100	150	RW	x	✓	
	I063 Valve acceleration time	ms	3141	1	10	10	150	RW	x	✓	
	I077 Valve holding current	%	3142	1	0	0	300	RW	x	✓	
	I064 Valve step mode		3143	1	3	0	4	RW	x	✓	0 = Full 1 = Half 2 = 1/4 3 = 1/8 4 = 1/16
	I065 Valve duty cycle	%	3144	1	100	5	100	RW	x	✓	
	I066 Minimum OD	%	3145	1	0	0	100	RW	x	✓	
	N032 Maximum OD	%	3146	1	100	0	100	RW	x	✓	
	I069 Valve OD during stop	%	3147	1	0	0	100	RW	x	✓	
	I070 Start backlash	%	3148	10	0	0	5	RW	x	✓	
	I071 Compensation backlash	%	3149	10	0	0	5	RW	x	✓	
	I072 Overdrive	%	3150	10	4	0	20	RW	x	✓	
	I073 Overdrive enable OD	%	3151	1	0	0	100	RW	x	✓	
I074 Overdrive block time	min.	3152	1	10	0	1440	RW	x	✓		
I076 Valve excitation time after stop	ms	3154	1	10	0	1000	RW	x	✓		
I078 Preset OD	%	3155	10	50	0	100	RW	x	✓		
I068 Valve neutral zone	%	3156	10	0.5	0	5	RW	x	✓		

Design Guide | Superheat controller type EKE 1A, EKE 1, EKE 1C

Group	Par. name	Unit	PNU	Par. scale	Default	Par. min.	Par. max.	Access	Locked by mainswitch	EEPROM	Remark
IO configuration											
Analogue Input	I020 AI1 configuration 1B/1C		3098	1	0	0	2	RW	✓	✓	0 = Not Used 1 = S3 2 = S4
	I021 AI4 configuration 1C		3099	1	0	0	2	RW	✓	✓	0 = Not Used 1 = ExtRef 2 = pc
	I022 AI5 configuration 1C		3100	1	0	0	2	RW	✓	✓	0 = Not Used 1 = S3 2 = S4
Digital Input	I080 AI4 configuration 1A/1B		3260	1	0	0	1	RW	✓	✓	0 = Not Used 1 = ExtRef
	O002 DI1 configuration		3101	1	1	0	1	RW	✓	✓	0 = Not Used 1 = Main Switch
	O022 DI2 configuration		3102	1	0	0	3	RW	✓	✓	0 = Not Used 1 = Defrost Start 2 = Preset OD 3 = Heat/Cool
Digital Output	O037 DI3 configuration		3103	1	0	0	3	RW	✓	✓	0 = Not Used 1 = Defrost Start 2 = Preset OD 3 = Heat/Cool
Digital Output	O013 DO1 configuration		3104	1	0	0	2	RW	✓	✓	0 = Alarm 1 = LLSV 2 = Max. cap
Sensor configuration											
Temperature sensor type	I040 S2 sensor configuration 1C		3105	1	0	0	6	RW	✓	✓	0 = Not defined 1 = EKS 221 2 = ACCPBT NTC10K 3 = MBT 153 10K 4 = 112CP 5 = Bus Shared 6 = AKS
	I081 S2 sensor configuration 1B		3266	1	0	0	5	RW	✓	✓	0 = Not defined 1 = EKS 221 2 = ACCPBT NTC10K 3 = MBT 153 10K 4 = 112CP 5 = Bus Shared
	I082 S2 sensor configuration 1A		3268	1	0	0	4	RW	✓	✓	0 = Not defined 1 = EKS 221 2 = ACCPBT NTC10K 3 = MBT 153 10K 4 = 112CP
	I041 S3 sensor configuration 1C		3106	1	0	0	6	RW	✓	✓	0 = Not defined 1 = EKS 221 2 = ACCPBT NTC10K 3 = MBT 153 10K 4 = 112CP 5 = Bus Shared 6 = AKS
	I083 S3 sensor configuration 1B		3264	1	0	0	5	RW	✓	✓	0 = Not defined 1 = EKS 221 2 = ACCPBT NTC10K 3 = MBT 153 10K 4 = 112CP 5 = Bus Shared
	I042 S4 sensor configuration 1C		3107	1	0	0	6	RW	✓	✓	0 = Not defined 1 = EKS 221 2 = ACCPBT NTC10K 3 = MBT 153 10K 4 = 112CP 5 = Bus Shared 6 = AKS
	I084 S4 sensor configuration 1B		3262	1	0	0	5	RW	✓	✓	0 = Not defined 1 = EKS 221 2 = ACCPBT NTC10K 3 = MBT 153 10K 4 = 112CP 5 = Bus Shared
Pe and Pc Pressure transmitter	I043Pe transmitter configuration 1C		3108	1	0	0	11	RW	✓	✓	0 = AKS 32R 1 = AKS 32 1-5V 2 = AKS 32 1-6V 3 = AKS 32 0-10V 4 = AKS 33 5 = 112CP 6 = XSK 7 = NSK 8 = OEM Ratio 9 = OEM Voltage 10 = OEM Current 11 = Bus shared
	I085 Pe transmitter configuration 1B		3270	1	0	0	8	RW	✓	✓	0 = Not defined 1 = AKS 32R 2 = ACCPBP Ratio 3 = 112CP 4 = OEM Ratio 5 = NSK 6 = AKS 32 1-5V 7 = OEM Voltage 8 = Bus shared
	I045 Pe ratio. low	%	3109	1	3	3	97	RW	x	✓	
	I046 Pe ratio high	%	3110	1	90	3	97	RW	x	✓	
	I047 Pe voltage low 1C	V	3111	10	0	0	10	RW	x	✓	
	I087 Pe voltage low 1A/1B	V	3276	10	0	0	10	RW	x	✓	
	I048 Pe voltage high 1C	V	3112	10	10	0	10	RW	x	✓	
	I088 Pe voltage high 1A/B	V	3274	10	5	0	5	RW	x	✓	
	I049 Pe current low	mA	3113	10	4	0	20	RW	x	✓	
	I050 Pe current high	mA	3114	10	20	0	20	RW	x	✓	
	O020 Pe transmitter min.	barg	3115	10	-1	-1	12	RW	x	✓	
	O021 Pe transmitter max.	barg	3116	10	12	-1	200	RW	x	✓	
	I044 Pc transmitter configuration 1C		3117	1	0	0	14	RW	✓	✓	ACCPBP Ratio 3 = 112CP 4 = OEM Ratio 5 = NSK 6 = AKS 32 1-5V 7 = OEM Voltage 8 = Bus shared 9 = AKS 32 1-6V 10 = AKS 32 0-10V 11 = AKS 33 12 = XSK 13 = ACCPBP Current 14 = OEM Current
	I023 Pc ratio. low	%	3118	1	3	3	97	RW	x	✓	
	I024 Pc ratio high	%	3119	1	97	3	97	RW	x	✓	
	I025 Pc voltage low	V	3120	10	0	0	10	RW	x	✓	
	I026 Pc voltage high	V	3121	10	10	0	10	RW	x	✓	
I038 Pc current low	mA	3122	10	4	0	20	RW	x	✓		
I039 Pc current high	mA	3123	10	20	0	20	RW	x	✓		
O047 Pc transmitter min.	barg	3124	10	-1	-1	0	RW	x	✓		
O048 Pc transmitter max	barg	3125	10	34	1	200	RW	x	✓		

Design Guide | Superheat controller type EKE 1A, EKE 1, EKE 1C

Group	Par. name	Unit	PNU	Par. scale	Default	Par. min.	Par. max.	Access	Locked by mainswitch	EEPROM	Remark
External reference signal	I090 Ext ref. configuration 1A		3280	1	0	0	2	RW	✓	✓	0 = Not Used 1 = V->SH 2 = V->Max OD
	I089 Ext ref. configuration 1B		3278	1	0	0	6	RW	✓	✓	0 = Not Used 1 = V->SH 2 = V->Max OD 3 = V->Temp 4 = Modbus->SH 5 = Modbus->Max OD 6 = Modbus->T
	O010 Ext ref. configuration 1C		3126	1	0	0	9	RW	✓	✓	0 = Not Used 1 = V->SH 2 = V->Max OD 3 = V->Temp 4 = Modbus->SH 5 = Modbus->Max OD 6 = Modbus->T. 7 = mA->SH 8 = mA->Max OD 9 = mA->Temp
	I037 Ext ref. current high	mA	3127	10	20	4	20	RW	x	✓	
	I036 Ext ref. current low	mA	3128	10	4	0	20	RW	x	✓	
	I035 Ext ref. voltage high	V	3129	10	10	0	10	RW	x	✓	
	I034 Ext ref voltage low	V	3130	10	0	0	10	RW	x	✓	
	I091 Driver reference configuration 1B		3282	1	0	0	2	RW	x	✓	0 = Voltage to OD 1 = Modbus to OD 2 = Modbus to steps
	I033 Driver reference configuration 1C		3131	1	0	0	3	RW	x	✓	0 = Voltage to OD 1 = Modbus to OD 2 = Modbus to steps 3 = Current to OD
I079 AI4 lowpass bandwidth		3257	1	5	0	5	RW	✓	✓	0 = None 1 = 4 Hz 2 = 2 Hz 3 = 1 Hz 4 = 1/2 Hz 5 = 1/5 Hz	
Control Basic											
Refrigerant configuration	O030 Refrigerant		3017	1	0	0	42	RW	✓	✓	0 = Undef 1 = R12 2 = R22 3 = R134a 4 = R502 5 = R717 6 = R13 7 = R13b1 8 = R23 9 = R500 10 = R503 11 = R114 12 = R142b 13 = R user 14 = R32 15 = R227 16 = R401A 17 = R507 18 = R402A 19 = R404A 20 = R407C 21 = R407A 22 = R407B 23 = R410A 24 = R170 25 = R290 26 = R600 27 = R600a 28 = R744 29 = R1270 30 = R417A 31 = R422A 32 = R413A 33 = R422D 34 = R427A 35 = R438A 36 = XP10 37 = R407F 38 = R1234ze 39 = R1234yf 40 = R448A, 41 = R449A, 42 = 452A
	O100 Refrigerant factor A1		3018	1000	9.8	0	12	RW	✓	✓	To be used only if O030 = 13
	O101 Refrigerant factor A2		3019	10	-2250	-3000	-1300	RW	✓	✓	
	O102 Refrigerant Factor A3		3020	10	253	210	300	RW	✓	✓	
	O103 Refrigerant min. temperature	°C	3021	10	-100	-100	60	RW	✓	✓	
	O104 Refrigerant max. temperature	°C	3022	10	100	-60	100	RW	✓	✓	
Start up	N102 Startup mode		3023	1	0	0	2	RW	x	✓	0 = Prop. Ctrl 1 = Fix OD w prot 2 = Fix OD wo prot
	N015 Startup time	sec.	3024	1	90	1	240	RW	x	✓	
	N104 Min. startup time	sec.	3025	1	15	1	240	RW	x	✓	
	N017 Startup OD	%	3026	1	32	1	100	RW	x	✓	
Superheat configuration	N021 SH reference mode		3027	1	2	0	3	RW	x	✓	0 = Fixed sp. 1 = Loadap 2 = MSS 3 = Delta temp
	N107 SH fixed setpoint	K	3028	10	7	2	40	RW	x	✓	
	N009 SH max.	K	3029	10	9	4	40	RW	x	✓	
	N010 SH min.	K	3030	10	4	2	9	RW	x	✓	
	N005 SH Tn	sec.	3031	1	90	20	900	RW	x	✓	
	N019 SH Kp Min.		3032	10	0.6	0.1	1	RW	x	✓	
	N004 SH Kp		3033	10	1.5	0.1	20	RW	x	✓	
	N020 SH KpTe		3034	10	3	0	20	RW	x	✓	
	N116 SH ref. delta temp. factor	%	3035	1	65	20	100	RW	x	✓	

Design Guide | Superheat controller type EKE 1A, EKE 1, EKE 1C

Group	Par. name	Unit	PNU	Par. scale	Default	Par. min.	Par. max.	Access	Locked by mainswitch	EEPROM	Remark
Control Advanced											
SH Close	N117 SH close function		3036	1	1	0	1	RW	x	✓	0 = Off 1 = On
	N119 SH close setpoint	K	3037	10	2	-5	20	RW	x	✓	
	N120 SH close Tn divide		3038	1	3	1	5	RW	x	✓	
S4 Temperature protection	N121 SH close Kp factor		3039	10	1.5	0.5	10	RW	x	✓	
	N126 Min. S4 mode		3042	1	0	0	1	RW	x	✓	0 = Off 1 = On
Superheat configuration Advance	N127 Min. S4 setpoint	°C	3043	10	5	-50	60	RW	x	✓	
	N018 Stability		3044	10	5	0	10	RW	x	✓	
	N129 T0 varies factor		3045	10	0	0	1	RW	x	✓	
MOP/LOP	N123 Limit Kp		3040	10	5	1	20	RW	x	✓	
	N125 Limit Tn	sec.	3041	1	45	20	900	RW	x	✓	
	N130 MOP function		3046	1	0	0	1	RW	x	✓	0 = Off 1 = On
	N011 MOP setpoint	°C	3047	10	0	-70	60	RW	x	✓	
	N140 LOP function		3048	1	0	0	1	RW	x	✓	0 = Off 1 = On
HCTP	N141 LOP setpoint	°C	3049	10	-40	-90	40	RW	x	✓	
	N142 LOP priority mode		3050	1	0	0	1	RW	x	✓	0 = Off 1 = On
	N131 LOP max. time	sec.	3051	1	120	0	600	RW	x	✓	
Compressor Feed Forward	N133 High cond. temp protection function		3053	1	0	0	1	RW	x	✓	0 = Off 1 = On
	N134 High cond. temp. protection setpoint	°C	3054	10	50	0	100	RW	x	✓	
	N135 Comp. speed feed forward Function		3055	1	0	0	1	RW	x	✓	0 = Off 1 = On
Diagnostic SH	N136 Comp FF low cap. point	%	3056	10	25	0	100	RW	x	✓	
	N137 Comp FF SH Tn factor		3057	1	2	1	5	RW	x	✓	
	N138 Average OD		4002	1	0	0	100	RW	x	x	
	N139 Estimated KpTe		4003	10	0	0	100	RW	x	x	
Emergency cooling	N128 Average delta temperature		4004	10	0	0	50	RW	x	x	
	N143 SH control sensor error action		3058	1	0	0	2	RW	x	✓	0 = Stop 1 = Fixed OD 2 = Average
	N144 Thermostatic sensor error action		3059	1	0	0	2	RW	x	✓	0 = Stop 1 = Fixed OD 2 = Average
	N145 Fixed OD during emergency cooling	%	3060	1	0	0	100	RW	x	✓	
Control Heatpump setup											
Control Heatpump setup	N112 Heat startup time	sec.	3061	1	90	1	600	RW	x	✓	
	N103 Heat min. startup time	sec.	3062	1	15	1	240	RW	x	✓	
	N105 Heat startup OD	%	3063	1	32	1	100	RW	x	✓	
	N106 Heat SH fixed setpoint	K	3064	10	7	2	40	RW	x	✓	
	N108 Heat SH max.	K	3065	10	9	4	40	RW	x	✓	
	N109 Heat SH min.	K	3066	10	4	2	9	RW	x	✓	
	N115 Heat SH ref. delta temp. factor	%	3067	1	65	20	100	RW	x	✓	
	N110 Heat SH Tn	sec.	3068	1	90	20	900	RW	x	✓	
	N111 Heat SH Kp min.		3069	10	0.6	0.1	1	RW	x	✓	
	N113 Heat SH Kp		3070	10	1.5	0.1	20	RW	x	✓	
	N114 Heat SH KpTe		3071	10	3	0	20	RW	x	✓	
	N118 Heat SH close setpoint	K	3072	10	2	-5	20	RW	x	✓	
	N124 Heat limit Tn	sec.	3073	1	45	20	900	RW	x	✓	
	N122 Heat limit Kp		3074	10	5	1	20	RW	x	✓	

Design Guide | Superheat controller type EKE 1A, EKE 1, EKE 1C

Group	Par. name	Unit	PNU	Par. scale	Default	Par. min.	Par. max.	Access	Locked by mains switch	EEPROM	Remark
Alarm configuration											
Alarm and Errors	A100 Low Min S4 delay	sec.	3081	1	60	0	1200	RW	x	✓	
	A101 Low Min S4 band	K	3082	10	2	0	30	RW	x	✓	
	A001 Upper temperature alarm	K	3083	10	5	0	40	RW	x	✓	
	A002 Lower temperature alarm	K	3084	10	3	0	40	RW	x	✓	
	A003 Temperature alarm delay	min.	3085	1	30	0	90	RW	x	✓	
	A034 Battery alarm		3086	1	0	0	1	RW	x	✓	0 = Off 1 = On
	A103 MOP alarm delay	sec.	3087	1	60	0	1200	RW	x	✓	
	A104 MOP alarm differential	K	3088	10	5	0	40	RW	x	✓	
	A105 LOP alarm delay	sec.	3089	1	60	0	1200	RW	x	✓	
	A106 LOP alarm differential	K	3090	10	5	0	40	RW	x	✓	
	A107 Cond.temp alarm delay	sec.	3091	1	120	0	1200	RW	x	✓	
	A113 Cond. temp. alarm differential	K	3092	10	5	0	40	RW	x	✓	
	A108 High SH alarm delay	sec.	3093	1	600	0	1800	RW	x	✓	
	A109 High SH alarm differential	K	3094	10	5	0	40	RW	x	✓	
A102 Low SH alarm delay	sec.	3095	1	60	0	1200	RW	x	✓		
A998 Low SH alarm differential	K	3096	10	3	0	40	RW	x	✓		
A112 Lack of capacity alarm delay	min.	3097	1	0	0	120	RW	x	✓		
Display											
MMIGRS2	O011 Language		3157	1	0	0	0	RW	✓	✓	0 = \$ActiveLanguageList
	K004 Login timeout	min.	3158	1	10	1	120	RW	x	✓	
	K006 Backlight timeout	min.	3159	1	2	0	120	RW	x	✓	
	O005 Password daily		3160	1	100	0	999	RW	x	✓	
	K002 Password service		3161	1	200	0	999	RW	x	✓	
	K003 Password commission		3162	1	300	0	999	RW	x	✓	
	K005 Contrast	%	3163	1	40	0	100	RW	x	✓	
	K001 Brightness	%	3164	1	80	0	100	RW	x	✓	
	R005 Display unit		3165	1	0	0	1	RW	x	✓	0 = METRIC 1 = IMPERIAL
	K010 Opening degree unit		3166	1	0	0	1	RW	x	✓	0 = Percent 1 = Step
Communication											
CAN/MODBUS	G001 Controller adr.		3167	1	1	1	127	RW	x	✓	
	G003 CAN bus min. update interval	sec.	3168	1	5	0	20	RW	x	✓	
	G004 Modbus min. update interval	sec.	3169	1	5	0	60	RW	x	✓	
	G005 Modbus baudrate		3170	1	6	0	8	RW	x	✓	0 = 0 1 = 1200 2 = 2400 3 = 4800 4 = 9600 5 = 14400 6 = 19200 7 = 28800 8 = 38400
	G008 Modbus mode		3171	1	1	0	2	RW	x	✓	0 = 8N1 1 = 8E1 2 = 8N2
	G007 Modbus mapping		3172	1	0	0	1	RW	x	✓	0 = Operation 1 = Setup
	G002 Can baudrate		3173	1	1	0	5	RW	x	✓	0 = 20k 1 = 50k 2 = 125k 3 = 250k 4 = 500k 5 = 1M
Signal sharing via BUS	G012 Signal sharing Pe		3174	1	0	0	1	RW	x	✓	0 = Off 1 = On
	G013 Signal sharing Pc		3175	1	0	0	1	RW	x	✓	0 = Off 1 = On
	G014 Signal sharing S3		3176	1	0	0	1	RW	x	✓	0 = Off 1 = On

Design Guide | Superheat controller type EKE 1A, EKE 1, EKE 1C

Main Group	Par. name	Unit	PNU	Par. scale	Default	Par. min.	Par. max.	Access	Locked by mainswitch	EEPROM	Remark
BUS Settings											
Modbus DI signal	X001 Modbus Heating		4043	1	0	0	1	RW	x	x	0 = Off 1 = On
	X002 Modbus preset OD		4044	1	0	0	1	RW	x	x	0 = Off 1 = On
	X003 Modbus defrost start		4045	1	0	0	1	RW	x	x	0 = Off 1 = On
	X004 Modbus main switch		4046	1	0	0	1	RW	x	x	0 = Off 1 = On
Modbus Sensor signal	X005 Bus shared Pc	barg	4047	100	0	-1	200	RW	x	x	
	X006 Bus shared Pe	barg	4048	100	0	-1	200	RW	x	x	
	X007 Bus shared S2	°C	4049	10	0	-200	200	RW	x	x	
	X008 Bus shared S3	°C	4050	10	0	-200	200	RW	x	x	
	X009 Bus shared S4	°C	4051	10	0	-200	200	RW	x	x	
Alarms status	X010 Bus ext. ref.		4052	10	0	-100	100	RW	x	x	
	X015 Number of active alarms		4055	1	0	0	100	R	✓	x	
	X016 Alarm notification		4056	1	0	0	1	R	✓	x	0 = No alarms 1 = Alarms active
	X040 Alarm status		4057	1	0	0	1	R	✓	x	0 = Off 1 = On
	X017 Warning status		4058	1	0	0	1	R	✓	x	0 = Off 1 = On
Valve status	X018 Error status		4059	1	0	0	1	R	✓	x	0 = Off 1 = On
	X027 Valve current position	Steps	4068	1	0	0	10000	R	x	x	
	X028 Valve target position	Steps	4069	1	0	0	10000	R	x	x	
User control LEDs	X031 Service number of steps		4072	1	0	-32767	32767	RW	x	x	
	X037 User controls LEDs		4074	1	0	0	1	RW	x	x	0 = Off 1 = On
	X038 Green LED pattern		4075	1	0	0	65535	RW	x	x	
	X039 Red LED pattern		4076	1	0	0	65535	RW	x	x	

Design Guide | Superheat controller type EKE 1A, EKE 1, EKE 1C

Main Group	Par. name	Unit	PNU	Par. scale	Default	Par. min.	Par. max.	Access	Locked by mainswitch	EEPROM	Remark
Service											
Status Readout	U118 Operation status		4005	1	0	0	20	R	x	x	0 = Power up 1 = Stop 2 = Manual 3 = Service 4 = Safe State 5 = Defrosting 6 = Valve driver 7 = Ther. Cutout 8 = Emer. cooling 9 = SH ctrl err. 10 = SH start Pctrl 11 = SH start fix OD 12 = SH ctrl normal 13 = SH ctrl MTR 14 = SH ctrl LOP 15 = SH ctrl minPC 16 = SH ctrl MOP 17 = SH ctrl maxPC 18 = SH ctrl SH cl 19 = SH ctrl minS4 20 = SH ctrl Tc
	U022 Actual SH reference	K	4006	10	0	0	100	R	x	x	
	U021 Actual superheat	K	4007	10	0	0	100	R	✓	x	
	U024 Actual OD	%	4008	10	0	0	100	R	✓	x	
	U100 Actual step	stp	4009	1	0	0	10000	R	✓	x	
	U028 Actual temperature ref.	K	4010	10	0	0	100	R	x	x	
	U020 S2 suction pipe	°C	4011	10	-50	-50	150	R	✓	x	
	U027 S3 media inlet	°C	4012	10	-50	-50	150	R	✓	x	
	U016 S4 media outlet	°C	4013	10	-50	-50	150	R	✓	x	
	U025 Pe evaporator	barg	4014	10	0	-1	200	R	✓	x	
	U026 Te saturated evaporation temperature	°C	4015	10	0	0	100	R	✓	x	
	U104 Pc condenser	barg	4016	10	0	-1	200	R	✓	x	
	U105 Tc saturated condenser temperature	°C	4017	10	0	0	100	R	✓	x	
	U101 Actual battery voltage	V	4018	10	0	0	30	R	x	x	
	U018 Thermostat cut-in time	min	4019	1	0	0	16300	R	✓	x	
	U119 Thermostat average cut-in time	min	4020	1	15	0	16300	R	x	x	
	U120 Thermostat average cut-out time	min	4021	1	15	0	16300	R	x	x	
	U122 Average temperature °C		4091	10	0	0	100	R	x	x	
	U121 Average SH K		4090	10	0	0	100	R	x	x	
	U058 Liquid line solenoid valve		4026	1	0	0	1	R	✓	x	0 = Off 1 = On
U114 Alarm relay		4027	1	0	0	1	R	✓	x	0 = Off 1 = On	
U007 External ref.signal	V	4028	10	0	0	12	R	x	x		
U006 External ref. signal	mA	4029	10	0	0	24	R	✓	x		
U107 Act. ext. ref. temperature offset	K	4030	10	0	0	40	R	x	x		
U108 Act.ext. ref. SH offset	K	4031	10	0	0	40	R	x	x		
Digital Input Readout	U109 DI main switch		4032	1	0	0	1	R	✓	x	0 = Off 1 = On
	U110 DI defrost start		4033	1	0	0	1	R	✓	x	0 = Off 1 = On
	U111 DI preset OD		4034	1	0	0	1	R	✓	x	0 = Off 1 = On
	U112 DI heating		4035	1	0	0	1	R	✓	x	0 = Off 1 = On
Manual operation	O018 Manual mode		4037	1	0	0	1	RW	x	x	0 = Off 1 = On
	B101 Manual mode timeout	sec.	3177	1	60	0	3600	RW	x	✓	
	O045 Manual OD	%	4037	10		0	100	RW	x	x	
	B100 Manual step	stp	4039	1		0	8000	RW	x	x	
	B104 Manual homeing		4039	1	1	0	1	RW	x	x	0 = Off 1 = On
	B103 Manual relay DO1		4040	1	1	0	1	RW	x	x	0 = Off 1 = On
	B007 Apply defaults		4041	1	0	0	3	RW	✓	x	0 = None 1 = Factory 2 = EKD 316 like 3 = EKC 316 like
B105 Enter service state		3178	1	0	0	1	RW	✓	✓	0 = Off 1 = On	

User interface module

MMIGRS2

Functional description

MMIGRS2 is a remote interface. It's fitted with a graphic display that allows user to use it as external display or parameter configuration tool. The connection with every unit of the EKE range is made through the CANbus network. All the information about the user interface is loaded inside the EKE controller; that's why there is no need of programming the MMIGRS2 interface. MMIGRS2 is powered externally or from the controller which it is connected to and automatically shows its user interface.



Features

- Full graphic LCD display, 128x64 dots resolution
- Easy connection to EKE CANbus network through telephone plug and CAN connector
- No need to be programmed: information about user interface is loaded from the EKE controller
- Powered by the EKE which it is connected to
- Dimensions 88x150 mm
- Panel and wall mounting
- IP64 protection rating on panel version

Approvals

CE compliance:

This product is designed to comply with the following EU standards:

- Low voltage guideline: 2014/35/EU
- Electromagnetic compatibility EMC: 2014/30/EU and with the following norms:
 - EN61000-6-1, EN61000-6-3 (immunity for residential, commercial and light-industrial environments)
 - EN61000-6-2, EN61000-6-4 (immunity and emission standard for industrial environments)
 - EN60730 (Automatic electrical controls for household and similar use)

UL approval:

- UL file E31024

Product part numbers

DESCRIPTION	CODE NO.
MMIGRS2, REMOTE DISPLAY, PANEL, Single pack	080G0294
MMIGRS2, REMOTE DISPLAY, WALL, Single pack	080G0295

MMIGRS2, REMOTE DISPLAY, PANEL, I-Pack	080G0297
--	----------

Note: both single pack codes (S) and industrial pack codes (I) include standard kit connector

User interface module

MMIGRS2

Dimensions

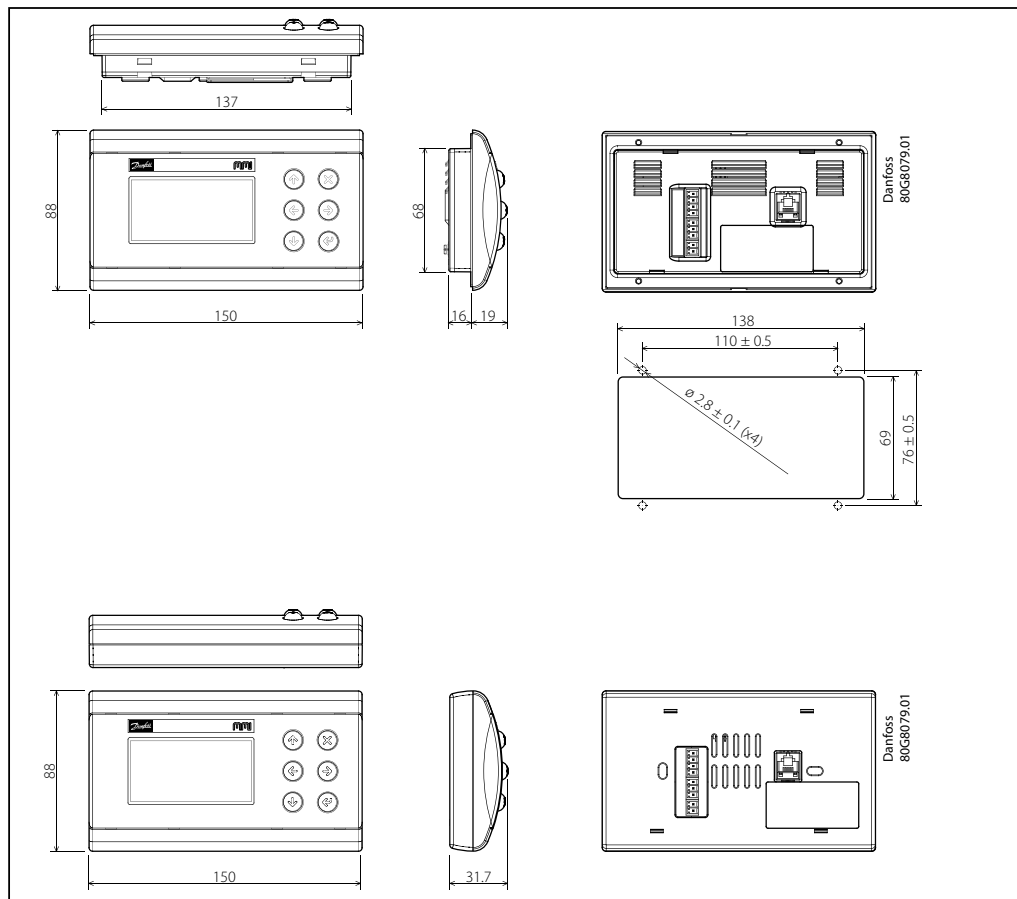

Technical data

TECHNICAL DATA	MMIGRS2
Power supply	<ul style="list-style-type: none"> - from the MCX through the RJ11 telephone connector - 12/30 V DC (separate power supply is recommended) - 24 V AC +10% / -15% (separate power supply is recommended) - maximum power consumption: 1.5 W
USER INTERFACE	
Display	<ul style="list-style-type: none"> - graphical LCD blue transmissive - white LED backlight with adjustable brightness via software - display format 128x64 dots - active visible area 66.5x33.2 mm - contrast adjustable via software
Keyboard	<ul style="list-style-type: none"> - 6 white LED backlight keys individually managed via software - function key configurable via the application software
Mounting	Based on the version: <ul style="list-style-type: none"> - panel mounting, see the drilling template in figure using the screws supplied in the packaging - wall mounting on a standard 3 modules box
OTHERS	
CANbus	•
Buzzer	•
RTC clock	
Degree of protection	<ul style="list-style-type: none"> - IP64 ~ NEMA3R (panel version) - IP40 (wall version)

Gateway

MMIMYK

Functional description

MMIMYK is the advanced “all in one” device that performs up to three different functions:

- Programming module
- Gateway
- Data logger

It has a bright graphic display and a keyboard that enable to configure the module to run several functions. It has also a slot for MMC card (Multi Media Card) to extend the memory capacity.



Features

- Full graphic OLED display, 128x64 dots resolution
- Easy connection to MCX CANbus network through telephone plug
- MMC card slot for easy software upload and datalogging
- Modbus RS485 serial interface
- Powered by the MCX which it is connected to or the other way round
- Can execute an application like any MCX device
- Dimensions 105x72 mm
- Mounting DIN rail or portable

CE compliance:

This product is designed to comply with the following EU standards:

- Low voltage guideline: 73/23/EEC
- Electromagnetic compatibility EMC: 89/336/EEC and with the following norms:
 - EN61000-6-1, EN61000-6-3 (immunity for residential, commercial and light-industrial environments)
 - EN61000-6-2, EN61000-6-4 (immunity and emission standard for industrial environments)
 - EN60730 (Automatic electrical controls for household and similar use)

Description	Code no.
MMIMYK, PC/MCX INTERFACE AND MCX PROGRAMMING, DATA LOGGING, S	080G0073

Note: single pack codes (S) don't include standard kit connectors

Gateway

MMIMYK

Functional description

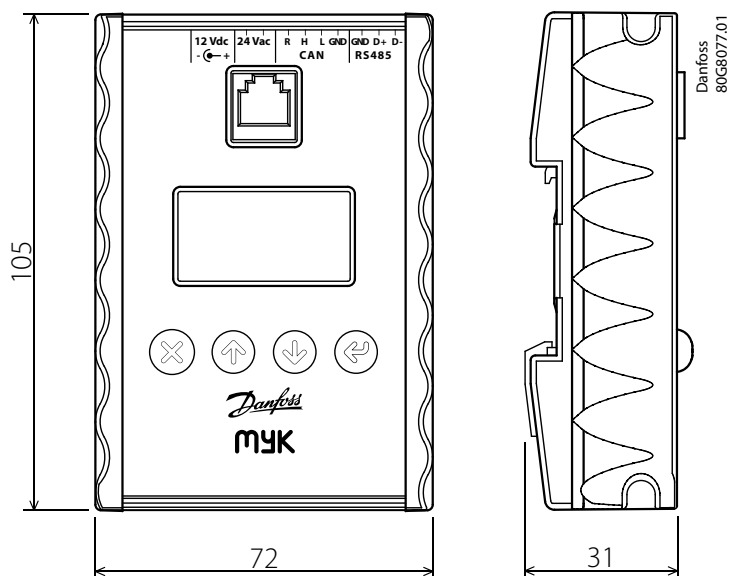

Technical data

TECHNICAL DATA	MMIMYK
OLED DISPLAY	
Display	Graphic OLED
Format	128x64 dots
Active visible area	35x17.5 mm
KEYBOARD	
Number of keys	4
Keys function	Set by the application software
MEMORY	
Internal	2 MB
MMC	Expansion slot (Multi Media Card) up to 2 GB

Accessory - Transformers

ACCTRD

Functional description

ACCTRD are safety transformers from 230 V AC to 24 V AC protected against short circuit and fully packed into epossidic resin for DIN rail mounting.



Approval

Compliance:

- UNI EN ISO 9001:2000
- IMQ
- VDE
- ENEC
- UL
- RoHS 2002/95/CE

TECHNICAL DATA	ACCTRD
POWER SUPPLY	
Primary voltage	230 V AC
Secondary voltage	24 V AC
OTHERS	
Internal protection device	PTC thermistor
Mounting	DIN rail

Product part numbers

DESCRIPTION	CODE NO.
ACCTRD, EMERGENCY TRANSFORMER, 230VAC/24VAC, 12VA, DIN MOUNTING	080G0223
ACCTRD, EMERGENCY TRANSFORMER, 230VAC/24VAC, 22VA, DIN MOUNTING	080G0225
ACCTRD, EMERGENCY TRANSFORMER, 230VAC/24VAC, 35VA, DIN MOUNTING	080G0226

Dimensions

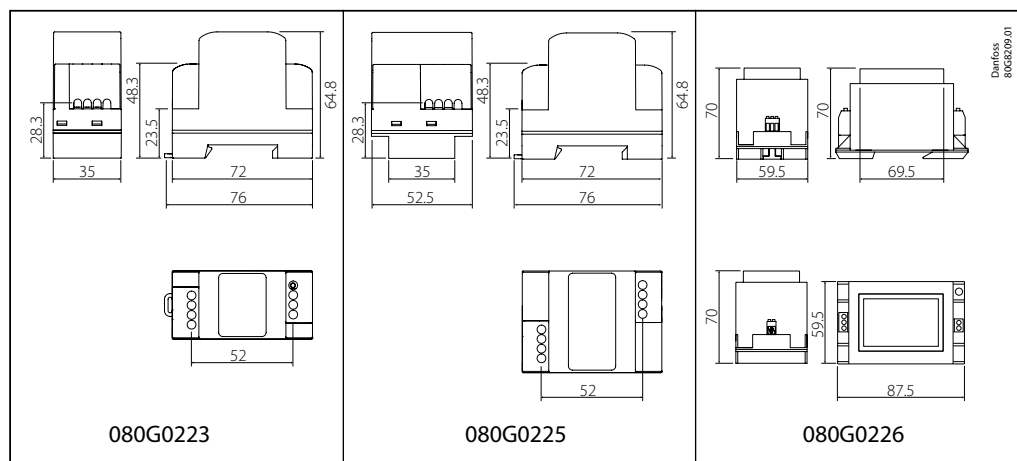

Accessory - Transformers

AK-PS

Functional description

AK-PC are safety transformers from 230 V AC to 24 V DC for DIN rail mounting..



Approval

Compliance:

- CE
- UL
- RoHS

Technical data

TECHNICAL DATA	AK-PS 150
POWER SUPPLY	
Primary voltage	AC 100 - 240 V
Frequency	50/60 HZ
Secondary voltage	24 V AC
Secondary current	1.5 Amp.

Product part numbers

DESCRIPTION	CODE NO.
AK-PS 150, Supply volt. AC 100 - 240 V, Freq. 50/60 HZ, 24V DC, 1.5 Amp	080Z0054

Environmental Range

Environmental Range:

Operation -25 °C t_{amb} +70 °C / -13 °F < t_{amb} < 158 °F
 Derating of output current 2.5 % / K > +55 °C / 131 °F
 Storage - 40 °C to +85 °C / -40 °F < t_{amb} < 185 °F
 Humidity 0 - 95 % RH, non condensing

Dimensions

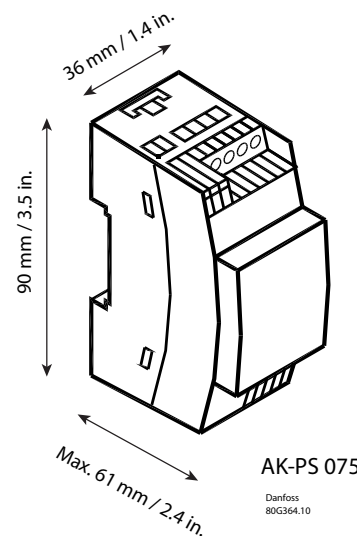
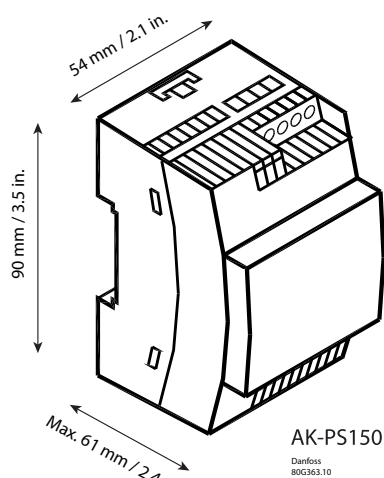

Weight

0.184 Kg

Accessory - Probe

ACCPBT

Functional description

The ACCPBT temperature probes series come to cover all needs of temperature monitoring, for low and high temperature applications. It includes NTC probes with IP67 and IP68. When more accuracy is required, then PT1000 probes IP68 are available.

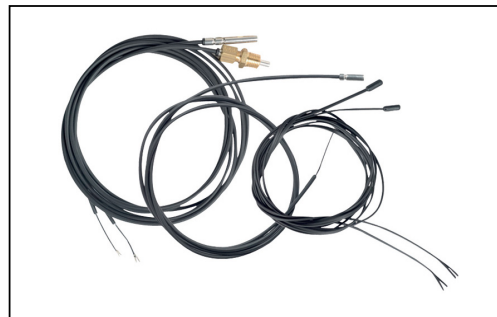

Dimensions

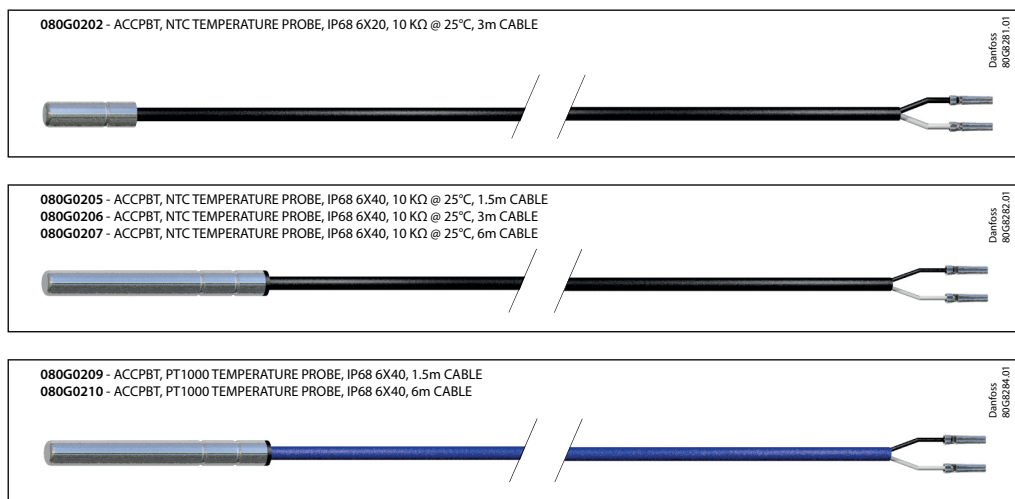

Product part numbers

DESCRIPTION	CODE NO.
ACCPBT, NTC TEMPERATURE PROBE, IP68 6X20, 3m CABLE	080G0202
ACCPBT, NTC TEMPERATURE PROBE, IP68 6X40, 1.5m CABLE	080G0205
ACCPBT, NTC TEMPERATURE PROBE, IP68 6X40, 3m CABLE	080G0206
ACCPBT, NTC TEMPERATURE PROBE, IP68 6X40, 6m CABLE	080G0207
ACCPBT, PT1000 TEMPERATURE PROBE, IP68 6X40, 1.5m CABLE	080G0209
ACCPBT, PT1000 TEMPERATURE PROBE, IP68 6X40, 6m CABLE	080G0210

Accessory - Cable

ACCCBI

Functional description

The ACCCBI connecting cables can provide all different needs for connection between MCX controller and MMI user interface.



Product part numbers

DESCRIPTION	CODE NO.
ACCCBI, TELEPHONE CABLE USER INTERFACE CONNECTOR, 1.5m CABLE	080G0075
ACCCBI, TELEPHONE CABLE USER INTERFACE CONNECTOR, 3m CABLE	080G0076
ACCCBI, MMILDS CABLE RJ12/JST PH, 2m CABLE	080G0239

System components



Danfoss can accept no responsibility for possible errors in catalogues, brochures and other printed material. Danfoss reserves the right to alter its products without notice. This also applies to products already on order provided that such alterations can be made without consequential changes being necessary in specifications already agreed. All trademarks in this material are property of the respective companies. Danfoss and the Danfoss logotype are trademarks of Danfoss A/S. All rights reserved.